



***In-market Application of Start-Stop
Systems in European Market***

Final Report / December 2011

P26844-01/ A1/ 01/ 61605

Project Manager
(Markus Kremer)

Department Manager
(Thomas Hülshorst)



Project: In-market Application of Start-Stop Systems in European Market	
Project for: FEV Inc. Project Manager: Markus Kremer	Project No.: P26844-01 Report No.: P26844-01_01.A1 Date: 09.12.2011
Subject/Objectives: Market study of available start-stop system in European market and recommendation of start-stop technology to be widely used in near future (2017+)	
Method/Solution: Extensive study of present and announced start-stop system used in vehicle for European market available through internet search. Utilization of customer independent background information available at FEV from number of projects. Usage of pertinent vast technical experience to perform an assessment and prediction of future trends	
Summary/Results: Start-stop technology is not a new technology rather it is well known technology gaining momentum in last few couple of years due to stringent carbon emission norms enacted by European parliament and the need by vehicle manufacturers to meet these stringent norms. Start-stop technology is not only promising but also costs a fraction of what its competitor technologies (full hybrid, plug-in hybrid or pure electric vehicle) do. Currently the market is more dominated by 'Belt-driven Starter Generator' and 'enhanced starter systems' as compared to other systems. Other technologies have also found a market application but in small quantities (e.g. Mazda, Honda) No technology is ever seamless and start-stop is no different to it. Start-stop places huge demand on the batteries as it requires starting a car many a times daily. Nonetheless major battery manufactures have already pinpointed this issue and have come up with new developments of their own.	
Conclusions/Recommendations: More than 50% of the newly registered vehicles will have start-stop as standard technology after 2013. Even though the technology is widely utilized for small / mid segment cars in Europe it also has high potential for compact and luxury car segments It can be expected, that especially micro-mild hybrid technology will gain increasing relevance in the coming years as technological challenges are solved (high voltage electrical system, for e.g. 48V). Start-stop is a key technology to be used in conjunction with other fuel saving technologies to attain the stringent carbon norms of 2020	
Keywords: Start-Stop vehicles Contents: 108 Pages	Project supervising:



Disclaimer:

This report was compiled on the basis of information, literature and other documents, which have been available in the internet by free access before the date of issue on December 6th, 2011.

Additionally FEV GmbH used its own technical knowledge and assessment competence about the topic of discussion to analyze information and derive conclusions indicated hereinafter in the report.

The information used for and contained within this report has been carefully selected and analyzed according to our best knowledge.

As the character of some of the used information implies that it cannot be reconfirmed nor validated and as some information ages rapidly, FEV therefore refuses any liability for the information contained in this report and cannot be made responsible for decisions and consequences derived by customers directly or indirectly, referring to statements made within this report.



Table of Contents	Page
1 Subject/ Objectives	5
2 Introduction	6
3 Need for Start-Stop Technology	8
4 Start-Stop System Overview	10
4.1 Belt-Driven Starter-Generator (BSG)	11
4.1.1 System Layout	11
4.1.2 Pros and Cons	12
4.1.3 Supplier Solutions	13
4.1.3.1 Valeo i-StARS (followed by StARS+X)	13
4.1.3.2 INA Hydraulic generator tensioning system	14
4.1.3.3 Other Suppliers	16
4.1.4 In-Market Applications (2012)	17
4.2 Enhanced Starter	27
4.2.1 System Layout	27
4.2.2 Pros and Cons	28
4.2.3 Supplier Solutions	28
4.2.3.1 Bosch: Efficiency Line Products	28
4.2.3.2 Denso: Enhanced Starter Products	32
4.2.4 In-Market Applications (2012)	36
4.3 Direct Starter	82
4.3.1 System Layout	82
4.3.2 Pros and Cons	82
4.3.3 Supplier Solutions	83
4.3.3.1 Mazda Idling stop technology (i-Stop)	83
4.3.4 In-Market Applications (2012)	84
4.4 Integrated / Crankshaft Starter Generator (ISG / CSG)	86
4.4.1 System Layout	87
4.4.2 Required Sensors and Actors	88
4.4.3 Required Software Features	89
4.4.4 Pros and Cons	89
4.4.5 Supplier Solutions	90
4.4.5.1 Integrated Starter Alternator Damper (ISAD) from Continental	90
4.4.5.2 DynaStart from ZF-Sachs	92
4.4.5.3 Integrated Motor Generator (IMG) from Bosch	94
4.4.5.4 Honda - Intergated Motor Assist (IMA)	95
4.4.6 In-Market Applications (2012)	97
5 Recommendation on Future Start-Stop System	100
6 Appendix	103
6.1 Additional cars with unknown Start-Stop technology	103
7 Reference	108



1 Subject/ Objectives

The main motive behind this market study is to perform an extensive survey of available start-stop system in European market as of 2010. Further to identify start-top system(s) widely used and to recommend a start-stop technology to be popularly used in near future (2017+).

The study contains

- A short introduction
- Need for start-stop technology
- An overview of various start-stop systems
- A short system layout for each start-stop system
- Required sensors and actuators for each start-stop system
- Salient features for each start-stop system
- Supplier solution with in-market application for each start-stop system
- A summary listing the findings of the market research
- Experts opinions for the various start-stop technology
- Conclusions and recommendations about start-stop technology to be popularly used in near future



2 Introduction

This study presents an overview of in market applications of start-stop systems for automobiles in Europe. The main types of start-stop systems with a short description are listed and a recommendation of a start-stop system to be widely used in future is presented.

Start-stop technology is one of the rapidly gaining momentum technologies in today's market world-wide. Its impact is to be seen significantly with every vehicle manufacturer providing it as a standard technology in European market to be followed by other markets worldwide driven by regional emission reduction regulations, for e.g. US market. Vehicle with start-stop technology should not be categorized under hybrid vehicles since electricity from the battery is not used to propel the vehicle, rather the technology is an important energy-saving feature used in hybrid vehicles. Start-stop technology save fuel by shutting off the engine when the vehicle is at a stop, such as traffic light and restart engine instantly when the driver accelerates the vehicle to proceed. The start-stop technology is a boon to both the vehicle manufacturer as well as the vehicle owner. The technology helps to reduce the CO₂ emission, playing a key role in a way to achieve stringent emission norms for vehicle manufacturer. On the other hand it reduces fuel consumption, which is what a vehicle owner mostly looks for in a vehicle, with ever increasing fuel prices.

Start-stop technology is not a new technology with references of the technology in use can be traced back to 1980's by major companies such as VW (VW Polo, "Formel E"), Fiat (Fiat Regata "ES") and in 1991 by VW (VW Golf 'Umwelt'). So it would be more appropriate to say that it is known technology gaining momentum and being developed in last few couple of years due to stringent carbon emission norms enacted by European parliament and the need by vehicle manufacturers to meet these stringent norms. Major European vehicle manufacturer producing large vehicles, such as VW, Daimler, BMW, Ford, Citroen and Volvo face an uphill task to comply with the emis-

**Introduction**

FEV

sion norms for 2013 (i.e. 130 g CO₂/km) and further proposed norms for 2020 (i.e. 95 g CO₂/km). With focused intentions of reducing carbon emissions to meet EU norms, vehicle manufacturer need to adopt new technologies. Start-stop technology is being aggressively used by various vehicle manufacturers in conjunction with other fuel saving technologies. Various OEM's are promoting their new fleet with start-stop technology in conjunction with other fuel saving technology under different concept name. Naming a few, 'e' by Audi, 'Efficient Dynamics' by BMW, 'BlueMotion' by VW, 'BlueEfficiency' by Daimler, 'MINIMALISN' by MINI, 'ECONetic' by Ford, 'ecoFLEX' by GM, 'AirDream' by Citroen, , 'eco²' by Renault, 'DRIVE' by Volvo, 'GreenLine' by Skoda, 'Ecomotive' by Seat, 'BlueDrive' by Hyundai, 'SkyActive' by Mazda, 'EcoDynamics' by KIA and so on.

Bosch predicts 50% of new vehicles in Europe to have start-stop functionality as standard system by 2012. Series production of Bosch start-stop system is available since 2007. [Source: Bosch Homepage]. With its ease of adoption and considerable benefits for small cost, the start-stop technology is poised to become a key technology in the automobile market worldwide.



3 Need for Start-Stop Technology

The European Union has been long establishing and implementing stringent emission norms (especially for CO₂ emissions) in Europe. In 2009 the European parliament established CO₂ emission regulations for new passenger cars to 130 g CO₂/km by 2015 and proposed 95 g CO₂/km by 2020 to be achieved. Additionally from 2012 until 2018, the manufacturers falling behind the specified average emissions target will be assessed a fine for excess emissions. For example, €5/per car for first gram of excess emissions per kilometer, €15 for second gram, €25 for third gram and €95 for all subsequent grams of excess emissions per kilometer. However, 2019 onwards, the fine for the first gram of excess CO₂ emissions per kilometer would already be €95. Though the regulations seem to be optimistic, all vehicle manufacturers have to fulfill it some way or the other. This in turn has led the vehicle manufacturers to explore various possibilities to reduce the fuel consumption of their fleet. One such technology is start-stop technology.

In comparison to different hybrid concepts (full hybrid, plug-in or pure electric vehicle) which carry significant costs for returns of improvement in fuel economy, start-stop technology costs relatively much less. It is estimated that start-stop vehicles costs few hundred of euros additional to conventional vehicles yielding significant improvement in fuel economy (approximately between 5-10%). Start-stop technology is not only promising but also costs a fraction of what its competitor technologies (full hybrid, plug-in hybrid or pure electric vehicle) do.

No technology is ever seamless and start-stop is no different to it. Start-stop places huge demand on the batteries as it requires starting a car many a times daily. In comparison to conventional battery, battery used for start-stop application must have primary function as ability to start engine high number of times and ability to have limited or extended 'engine off periods. Nonetheless major battery manufactures have already pinpointed this issue and have come up with new developments of their own.

**Need for Start-Stop Technology**

FEV

For example 'Varta Batteries' have come up with products like 'start-stop Battery' based on 'Enhanced Flooded Battery' (EFB) technology and 'start-stop Plus Battery' based on 'Absorbent Glass Mat' (AGM) technology, specifically designed for start-stop system applications in vehicles and predict 70% of all new vehicles to feature start-stop technology by 2015 in Europe. Another manufacturer 'Exide technologies' have also developed battery products well suited for start-stop technology based on 'Enhanced Cycling Mat' (ECM) technology to be seen in Fiat, Alfa Romeo, Lancia and Toyota cars and 'Absorbent Glass Mat' (AGM) technology to be seen in BMW efficient Dynamics series. Further the conventional starter motor replaced by reversible alternator for most of start-stop systems not only starts the engine but also supplies electrical consumers in cars and also charges the vehicle battery. Such innovations as use of reversible alternators and technological advances as in case of batteries, have paved the way for start-stop technology to be used in vehicles. As the technology prospers and the start-stop system evolves, the limitations will be vastly reduced and no longer considered limitations.

To sum up, with ever increasing customer demand for eco-friendly cars, depleting oil reserves, stringent emission regulation, there is no doubt that start-stop technology will be a standard or even mandatory technology for vehicles in future.



4 Start-Stop System Overview

Start-stop technology in simple words is to automatically switch off the engine every time the vehicle stops or engine is idling and to restart it instantly as and when needed. It is most efficient in urban traffic where vehicle spends significant amount of time waiting at traffic lights or stands still in a traffic jam, thus saving fuel consumed dramatically in heavy traffic conditions otherwise and reducing CO2 emissions.

Engine start-stop during vehicle driving, i.e. coast down, will be implemented in most systems soon. Integrated Starter Generator systems already provide this functionality.

Different start-stop technologies have been adopted by various vehicle manufacturers. Following is a list of commonly found start-stop system in European market

1. Belt Driven starter generator
2. Enhanced starter
3. Direct Starter
4. Integrated Starter Generator



4.1 Belt-Driven Starter-Generator (BSG)

The conventional starter motor and alternator can be replaced by a BSG system. The BSG minimizes the engine start-up time. It also charges the vehicle battery by recuperating energy.

4.1.1 System Layout

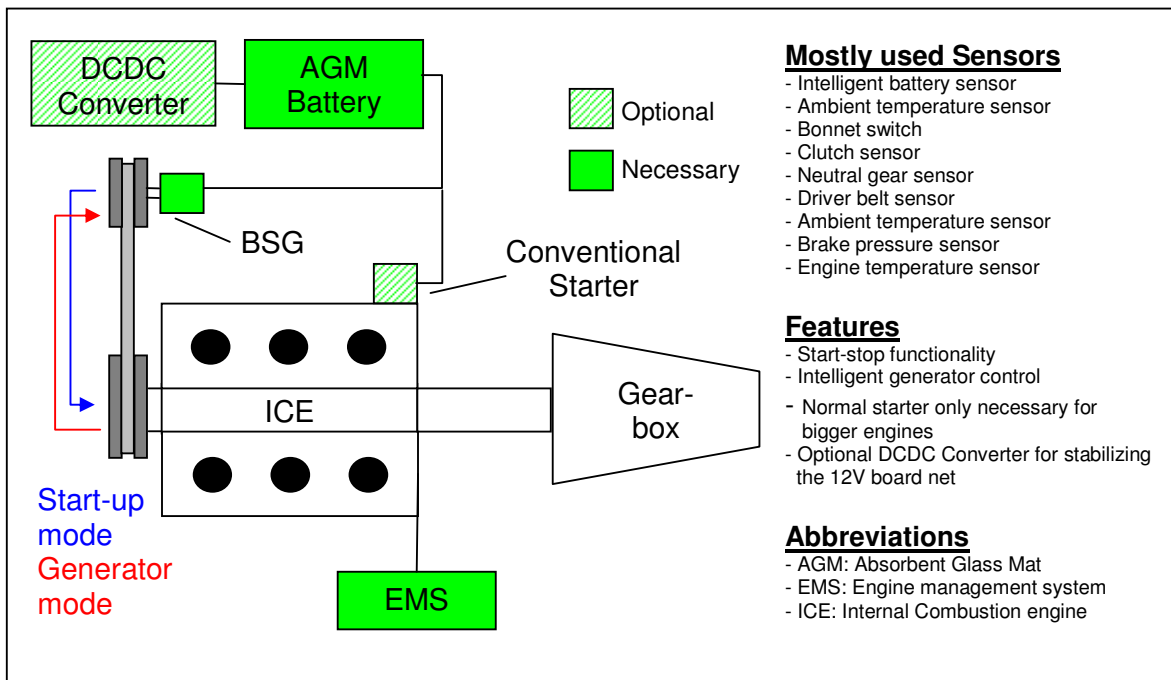

Figure: System layout of Belt-driven Starter Generator (BSG)

The BSG is integrated into the belt drive system of a conventional combustion engine. It can be integrated in the same way as a normal alternator. It has the same fixing points as the normal alternator and can be used as a flexible replacement solution for a normal alternator.

A major modification on the belt drive system is the reinforcement of the belt tensioning system. This is necessary because a normal alternator is using the force of the



belt power transfer in only one direction, while the BSG acts bidirectional on the belt to speed up the combustion engine during start-up. Higher forces and wear have to be taken into account for the new belt system with a BSG concept. Therefore the belt has to be tensioned more than a normal belt drive system. The larger forces lead to a re-design of the belt drive system. E.g. wider belt, the tension roller has to increase the belt tension, deflection puller have to be adapted regarding higher bearing force and the bearings have to be reinforced. Changes on the belt drive system lead to a different load on the crankshaft and therefore the flywheel has to be modified.

4.1.2 Pros and Cons

Pros:

- Easy to integrate
- No additional starter necessary (in case of small engines)
- Smooth restart

Cons:

- Belt drive system has to be changed
- Cold start is difficult with bigger engines (additional conventional starter required)
- Flywheel has to be modified



4.1.3 Supplier Solutions

Some most representative BSG suppliers identified in market are

- Valeo
- INA (Schaeffler Technologies)
- Bosch
- Denso

4.1.3.1 Valeo i-StARS (followed by StARS+X)



Figure: Start-Stop System i-StARS of Valeo

The first system in series production is the Valeo StARS system. It went into series production in 2004 for PSA in C2 and C3 Citroen until 2007 and Smart mhd.

The i-StARS is the next generation of BSG systems from Valeo. Herein the BSG was modified to already stop the combustion engine while the vehicle is still driving up to 8 km/h in an automated manual transmission application and up to 20 km/h with a manual transmission.



Both systems are not capable of full regenerative braking, because the high power which has to be stored is much more than a normal 12V battery can handle. For such an application Valeo has developed a new system called StARS+X. It is equipped with a pack of ultra-capacitors and a DC/DC converter. The regenerated energy during phases of speed reduction is stored inside of the ultra-capacitors and fed back to the 12V electrical system via the DC/DC converter. The BSG can not only start and stop the engine but also boost during phases of acceleration. A car with such a system is not any more a micro hybrid, but a micro-mild hybrid vehicle.

4.1.3.2 INA Hydraulic generator tensioning system

INA Schaeffler Technologies, a German Tier 1 supplier, has introduced a starter generator belt drive system which uses BSG itself as a tensioning system. The idea uses a rotating bearing arrangement for the generator supported by a hydraulic tensioning element. Few salient features for the system include ease of implementation, compact arrangement and adaptability for wide range of applications.

During the startup process, the torque on the generator pulley introduced into the belt drive acts on the BSG housing as an equivalent counter torque. This counter torque can result, with an appropriate arrangement of the rotation point, in an automatic increase in the preload. This effect supports torque transmission during engine startup. In generator operation, this effect is reversed, the preload is reduced and the belt life is increased.

Following figures illustrates the operating modes for the system



Start-Stop System Overview

FEV

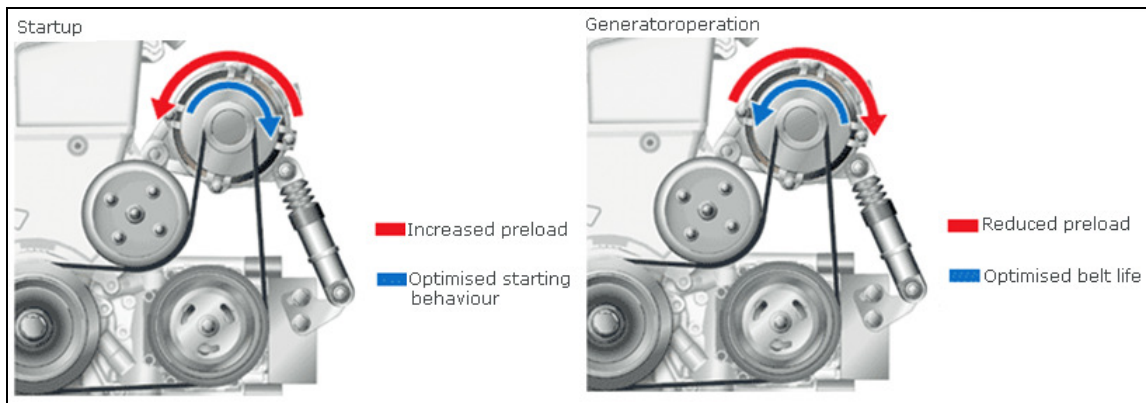

Figure: Start-Stop System INA (Schaeffler Technologies) [Source: INA Homepage]



4.1.3.3 Other Suppliers

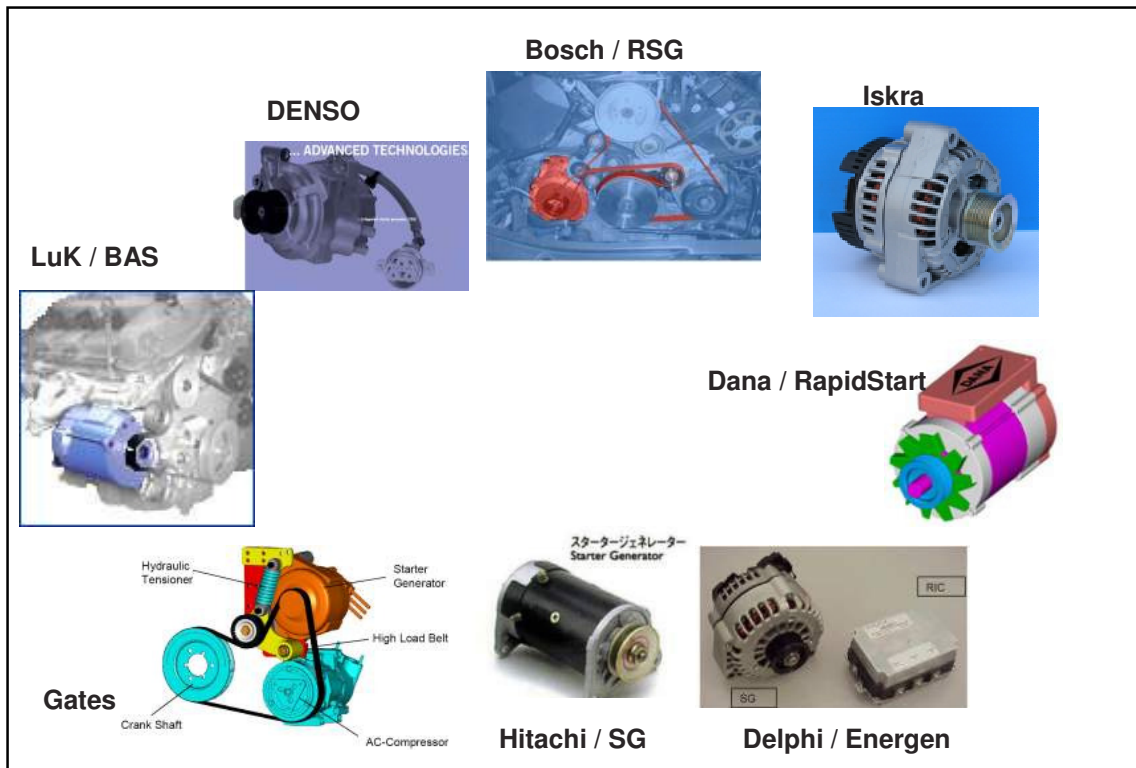

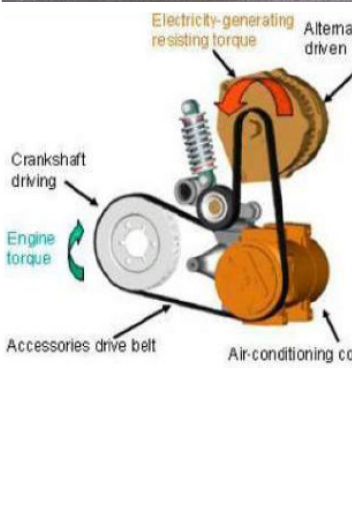

Figure: Suppliers for Belt-Driven start-stop Systems [Source: INA Homepage]



4.1.4 In-Market Applications (2012)

Citroen C3 e-HDi 90 (Compact Car)

<p>Starter/Generator Type / Supplier:</p>	<p>Belt-Driven /Valeo (i-StARS, 2.Gen)</p>		
<p>Functional Scope</p>	<p>Mild Hybrid, start-stop, Recuperation</p> <p>Recuperative Braking is engaged when the foot is lifted from the accelerator (Volt Control alternator management system)</p> <p>Starter-Alternator (2,2kW) Engine Restart within 0,4sec</p> <p>Engine shut-off and restart while still moving between 8-20kph (depending on gearbox, neutral)</p> <p>SuperCaps/PowerElectronics: - boost the battery to drive the reversible alternator at start - Support Vehicle electrical voltage at start</p>		
<p>Battery System</p>	<p>12V-Battery, AGM-Battery, SuperCaps (200F, 20-30V) for Power Electronics</p>		
<p>Additional Sensors</p>	<ul style="list-style-type: none"> - Power electronics for SuperCaps - Dashboard Pushbutton for Start/Stop - Clutch Sensor - Neutral Sensor of Gearbox (manual) 		
<p>Modified Components</p>	<ul style="list-style-type: none"> - Starter-Alternator is a synchronous machine (3 phase) - Starter-Alternator AC/DC converter uses FET's for rectification - belt tensioner for both directions power - reinforced dual mass flywheel - reinforced injection pump - reinforced crankshaft bearings - turbo lubrication system 		
<p>Engine</p>	<p>I4, e-HDi 90 Diesel, Turbo, High</p>		



Start-Stop System Overview

FEV

	Pressure Direct Injection, 1560cm ³ , 68kW, 3,6l/100km (65 MPG)	
Transmission	5-speed, manual	
SOP	2011	

Citroen DS3 (Compact Car)

Starter/Generator Type / Supplier:	Belt-Driven /Valeo (i-StARS, 2.Gen)	
Functional Scope	Similar as in Citroen C3	
Battery System	12V-Battery, AGM-Battery, SuperCaps (200F, 20-30V) for Power Electronics	
Additional Sensors	Similar as in Citroen C3	
Modified Components	Similar as in Citroen C3	
Engine	14- e-HDi 90 Diesel , 1560cm ³ , 68kW (93 PS), Euro 5, 3.3-4.4l/100km (71-53MPG)	
Transmission	5-speed, manual	
SOP	2011	

Citroen C4 (Compact Car)

Starter/Generator Type / Supplier:	Belt-Driven /Valeo (i-StARS, 2.Gen)	
Functional Scope	Similar as in Citroen C3	
Battery System	12V-Battery, AGM-Battery, SuperCaps (200F, 20-30V) for Power Electronics	
Additional Sensors	Similar as in Citroen C3	
Modified Components	Similar as in Citroen C3	
Engine	14- e-HDi 110 Diesel , 1560cm ³ , 82kW (112 PS), Euro 5, 3.5-4.2l/100km (67-56MPG)	
Transmission	6-speed, manual	
SOP	2011	



Start-Stop System Overview

FEV

Citroen C4 Picasso (Van/Mini Van)

Starter/Generator Type / Supplier:	Belt-Driven /Valeo (i-StARS, 2.Gen)	
Functional Scope	Similar as in Citroen C3	
Battery System	12V-Battery, AGM-Battery, SuperCaps (200F, 20-30V) for Power Electronics	
Additional Sensors	Similar as in Citroen C3	
Modified Components	Similar as in Citroen C3	
Engine	I4- e-HDi 110 Diesel , 1560cm ³ , 82kW (112 PS), Euro 5, 4.5-5.1l/100km (52-46MPG)	
Transmission	6-speed, manual	
SOP	2011	

Citroen DS4 (Compact Car)

Starter/Generator Type / Supplier:	Belt-Driven /Valeo (i-StARS, 2.Gen)	
Functional Scope	Similar as in Citroen C3	
Battery System	12V-Battery, AGM-Battery, SuperCaps (200F, 20-30V) for Power Electronics	
Additional Sensors	Similar as in Citroen C3	
Modified Components	Similar as in Citroen C3	
Engine	I4- e-HDi 110 Diesel , 1560cm ³ , 82kW (112 PS), Euro 5, 4.1-4.8l/100km (57-49MPG)	
Transmission	6-speed, manual	
SOP	2011	



Start-Stop System Overview

FEV

Citroen C5 (Luxury Car)

Starter/Generator Type / Supplier:	Belt-Driven /Valeo (i-StARS, 2.Gen)	
Functional Scope	Similar as in Citroen C3	
Battery System	12V-Battery, AGM-Battery, SuperCaps (200F, 20-30V) for Power Electronics	
Additional Sensors	Similar as in Citroen C3	
Modified Components	Similar as in Citroen C3	
Engine	I4- e-HDi 110 Diesel , 1560cm ³ , 82kW (112 PS), Euro 5, 4.1-5.5l/100km (57-43MPG)	
Transmission	6-speed, manual	
SOP	2011	

Citroen Berlingo (Van/Mini Van)

Starter/Generator Type / Supplier:	Belt-Driven /Valeo (i-StARS, 2.Gen)	
Functional Scope	Similar as in Citroen C3	
Battery System	12V-Battery, AGM-Battery, SuperCaps (200F, 20-30V) for Power Electronics	
Additional Sensors	Similar as in Citroen C3	
Modified Components	Similar as in Citroen C3	
Engine	I4- e-HDi 90 Diesel , 1560cm ³ , 68kW (93 PS), Euro 5, 4.8-6.2l/100km (49-38MPG)	
Transmission	5-speed, manual	
SOP	2011	



Start-Stop System Overview

FEV

Citroen Nemo (Van/Mini Van)

Starter/Generator Type / Supplier:	Belt-Driven /Valeo (i-StARS, 2.Gen)	
Functional Scope	Similar as in Citroen C3	
Battery System	12V-Battery, AGM-Battery, SuperCaps (200F, 20-30V) for Power Electronics	
Additional Sensors	Similar as in Citroen C3	
Modified Components	Similar as in Citroen C3	
Engine	I4- HDi 75 Diesel , 1248cm ³ , 55kW (75 PS), Euro 5, 3.8-5.0l/100km (62-47MPG)	
Transmission	5-speed, manual / automatic	
SOP	2011	



Start-Stop System Overview

FEV

Mercedes-Benz A 150 Blue Efficiency (Compact Car)

Starter/Generator Type / Supplier:	Belt-Driven /Valeo (StARS)	
Functional Scope	<p>StARS Micro-Hybrid System</p> <p>Stop in neutral, keep brake pedal pushed (Driver-Detection) step off brake pedal starts the engine again</p> <p>Engine off below 8kph</p>	
Battery System	AGM-Battery (Varta)	
Additional Sensors		
Modified Components		
Engine	<p>I-4 1.2 Diesel, 1991 cm³, 60 kW</p> <p>I-4 1.5 Gasoline, 1498 cm³, 70 kW</p> <p>I-4 1.8 Diesel, 1699 cm³, 85 kW</p>	
Transmission	5-speed, manual	
SOP	2009	



Start-Stop System Overview

FEV

Mercedes-Benz B-class Blue Efficiency (Compact Car)

Starter/Generator Type / Supplier:	Belt-Driven /Valeo (StARS)	
Functional Scope	<p>StARS Micro-Hybrid System</p> <p>Stop in neutral, keep brake pedal pushed (Driver-Detection) step off brake pedal starts the engine again</p> <p>Engine off below 8kph</p>	
Battery System	AGM-Battery (Varta)	
Additional Sensors		
Modified Components		
Engine	<p>I-4 1.8 Diesel, 1796 cm³, 80 kW 4,6 l / 100 km combined NEDC, 121 – 114 g/km CO₂</p> <p>I-4 1.8 Diesel, 1796 cm³, 100 kW 4,6 l / 100 km combined NEDC, 121 – 115 g/km CO₂</p> <p>I-4 1.8 Gasoline, 1796 cm³, 90 kW, 6,2l / 100 km combined NEDC 144 – 137 g/km CO₂</p> <p>I-4 1.8 Gasoline, 1796 cm³, 115 kW , 6,2l / 100 km combined NEDC, 144 – 138 g/km CO₂</p>	
Transmission	6-speed, manual	
SOP	2009	



Start-Stop System Overview

FEV

Mercedes-Benz C-class Blue Efficiency (Midsize Car)

Starter/Generator Type / Supplier:		
Functional Scope	Stop in neutral, keep brake pedal pushed (Driver-Detection) step off brake pedal starts the engine again Engine off below 8kph	
Battery System	AGM-Battery (Varta)	
Additional Sensors		
Modified Components		
Engine	Model C180 CDI, 2143 ccm, Diesel , 4 cylinder, 88 kW, Model C200 CDI, 2143 ccm, Diesel , 4 cylinder, 100 kW Model C220 CDI, 2143 ccm, Diesel , 4 cylinder, 125 kW Model C250 CDI, 2143 ccm, Diesel , 4 cylinder, 150 kW Model C250 CDI 4Matic, 2143 ccm, Diesel , 4 cylinder, 150 kW Model C350, 2987 ccm, Diesel , 6 cylinder, 195 kW Model C180, 1796 ccm, Gasoline , 4 cylinder, 115 kW Model C200, 1796 ccm, Gasoline , 4 cylinder, 135 kW Model C250, 1796 ccm, Gasoline , 4 cylinder, 150 kW Model C350, 3498 ccm, Gasoline , 6 cylinder, 225 kW Model C350 4Matic, 3498 ccm,	



Start-Stop System Overview

FEV

	Gasoline , 6 cylinder, 225 kW	
Transmission	6-speed, manual, 7G-TRONIC Plus Automatic	
SOP	2009	

Mercedes-Benz S-class Blue Efficiency (Luxury Car)



Starter/Generator Type / Supplier:		
Functional Scope	<p>Stop in neutral, keep brake pedal pushed (Driver-Detection) step off brake pedal starts the engine again</p> <p>Engine off below 8kph</p>	
Battery System	AGM-Battery (Varta)	
Additional Sensors		
Modified Components		
Engine	<p>Model S250 CDI, 2143 ccm, Diesel, 4 cylinder, 150 kW</p> <p>Model S350 CDI, 2987 ccm, Diesel, 6 cylinder, 190 kW</p> <p>Model S350, 3498 ccm, Gasoline, 6 cylinder, 225 kW</p> <p>Model S350 4Matic, 3498 ccm, Gasoline, 6 cylinder, 225 kW</p> <p>Model S500, 4663 ccm, Gasoline, 8 cylinder, 320 kW</p> <p>Model S500 4Matic, 4663 ccm, Gasoline, 8 cylinder, 320 kW</p> <p>Model S63 AMG, 5461 ccm, Gasoline, 8 cylinder, 400 kW</p>	
Transmission	6-speed, manual, 7G-TRONIC Plus Automatic, AMG Speedshift MCT 7G-sport gearbox	
SOP	2009	



Start-Stop System Overview

FEV

Smart Fortwo mhd (Micro Car)

Starter/Generator Type / Supplier:	Belt-Driven / Valeo (StARS)	
Functional Scope	- Engine off when braking below 8km/h (5mph) - Regenerating to LV-Bord Grid	
Battery System	12V AGM-Battery, Varta	
Additional Sensors		
Modified Components		
Engine	I3, Gasoline , 999cm ³ 45-52kW, Euro5, 4,2-4,4l/100km (53-56 MPG), w/o Start/Stop 0,3l more	
Transmission	5 speed AMT	
SOP	2007	



4.2 Enhanced Starter

Enhanced starter start-stop system consists of a modified starter to meet the requirement of multiple starts as compared to conventional starter. The system also consists of a modified generator for recuperation.

4.2.1 System Layout

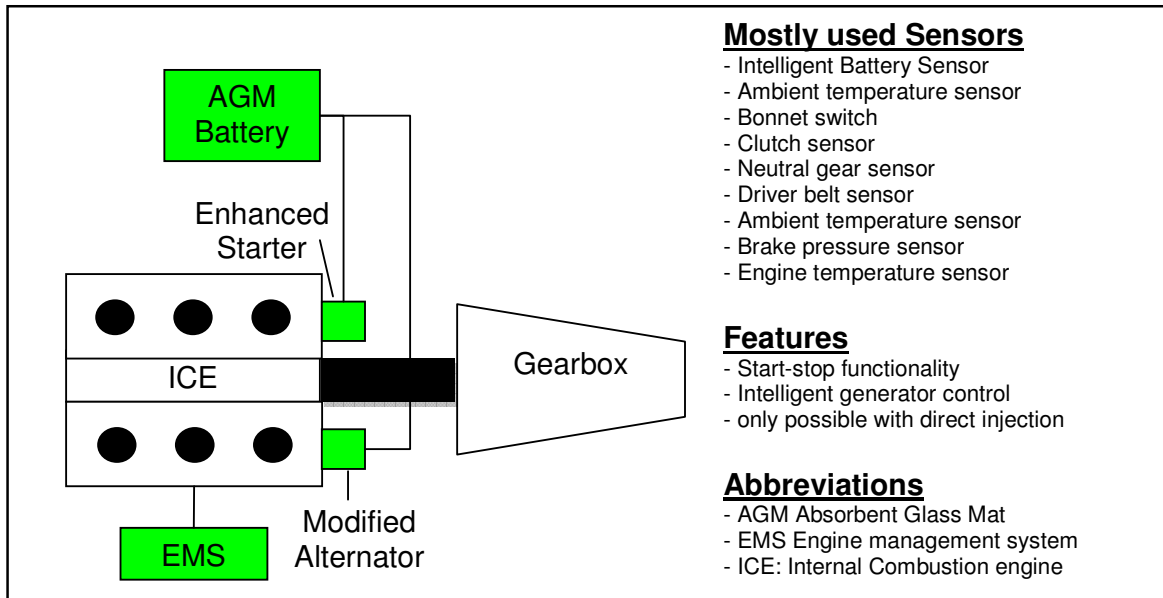

Figure: System Layout of Enhanced Starter



Other Components affected:

- Wiring harness
- Mountings/Brackets
- Belt/Pulleys/Shafts
- Flywheel
- Gears/Differential
- AC Compressor
- EHPS
- Safety
- DPF (for diesel cars)

4.2.2 Pros and Cons

Pros:

Cheap solution

Cons:

Not very comfortable restart

Only with the latest systems a restart from a certain speed possible

4.2.3 Supplier Solutions

Some most representative enhanced starter products identified in market are

1. Bosch: Efficiency Line (EL) Products
2. Denso: Enhanced Starter Products

4.2.3.1 Bosch: Efficiency Line Products



Bosch has developed enhanced starter motor and generator under its 'Efficiency Line' (EL) to specifically suit the adaptation of start-stop technology in vehicles. Following are the product range from Bosch

a. Starter Motor

Bosch has developed two starter motor to fulfill the demands of a start-stop system in vehicle namely 'Nose-type starter motor' suitable for passenger cars and 'Noseless starter motor' suitable for heavy duty vehicles. The number of starting operations to be performed by a starter motor in a vehicle with start-stop technology has increased considerably as compared to that of conventional vehicle. Bosch claims greater design strength such as strengthening of bearings subjected to heavy loading, improvement of planetary gear mechanism, strengthening of pinion-engaging mechanics, optimization of commutator for longer life, has enabled these starter motor to survive frequent starts throughout the lifetime of vehicle without suffering damage. Bosch began series production of these starter motors since 2007 and find application in cars such as Porsche Panamera and VW Passat (with dual clutch systems), Fiat 500 (automated manual) and latest Audi A8(torque converter system). [Source: <http://ev.sae.org/article/9135>]



Figure: Nose-type starter motor (left-side) and Noseless starter motor from Bosch [Source: Starter Motors and Generators: start/stop technology, Bosch Brochure]



For future systems Bosch is also developing permanent engaged starters which can provide starting of the engine not only at zero speed but up to certain speeds.

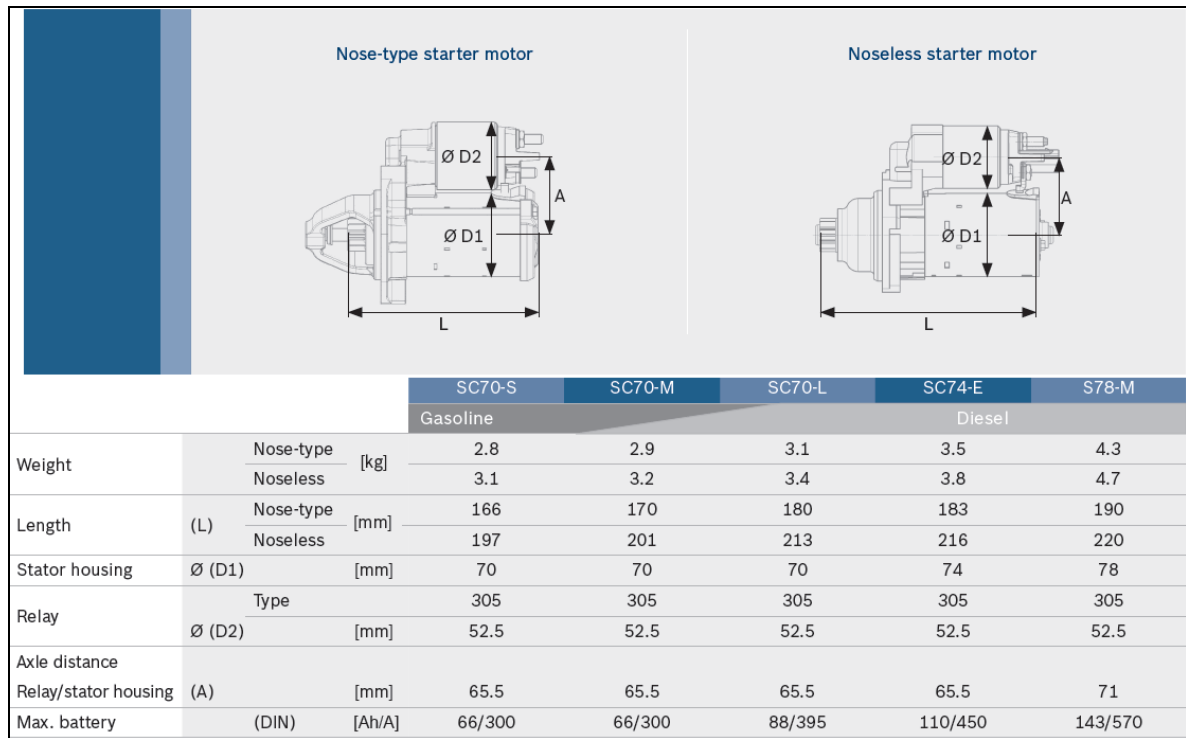

Figure: Overview of Bosch Start/Stop starter motor [Source: Starter Motors and Generators: start/stop technology, Bosch Brochure]

b. Efficiency Line (EL) Alternator

The new EL alternators from Bosch charge the battery quickly permitting frequent and effective utilization of start-stop function. Bosch claims that the new EL alternators provide powerful performance at low rotation speed enabling quick battery recharge, thus after every restart, sufficient electrical energy is available for further restarts as and when required. These systems only switch off the engine if the state of battery charge permits reliable restart. The EL alternators are in series production and find application in start-stop technology implemented in MINI and Ford Transit.



Start-Stop System Overview

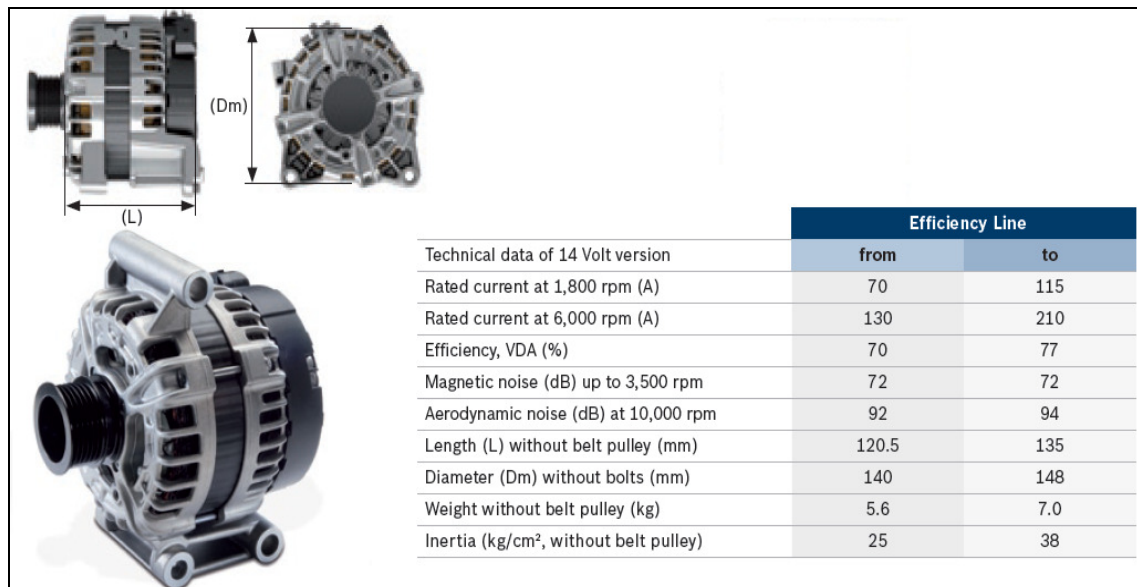

Figure : Efficiency Line Generator for start-stop technology from Bosch [Source: Starter Motors and Generators: start/stop technology , Bosch Brochure]

Following is an overview of the components used for Bosch Start-stop technology

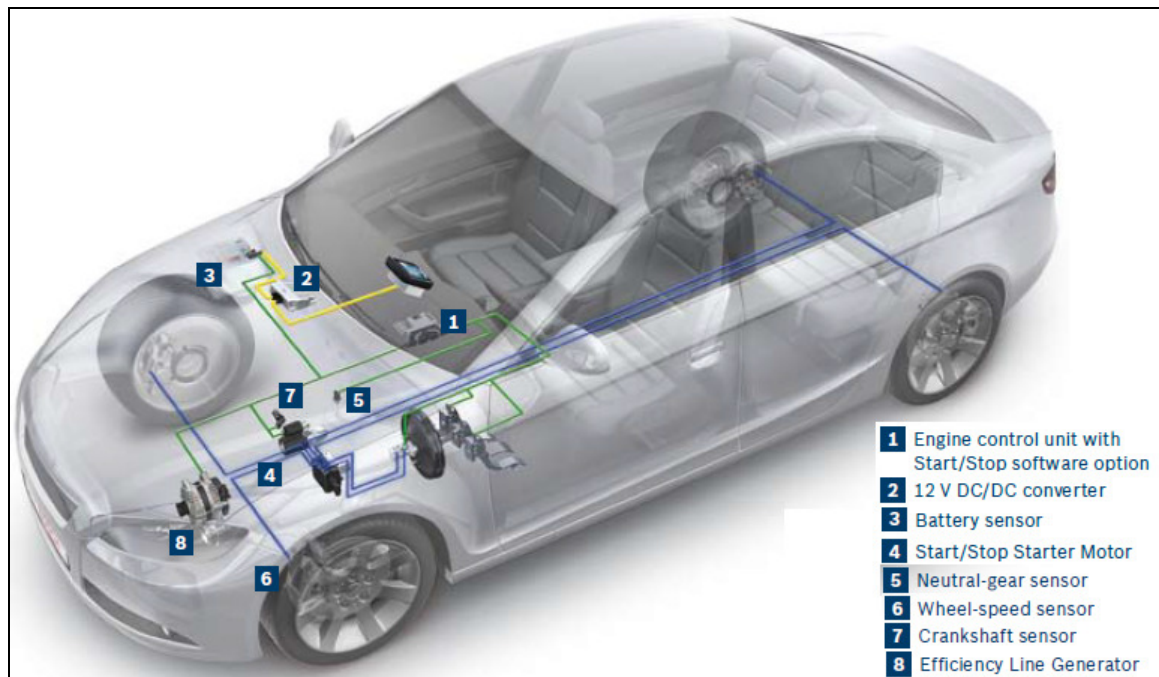

Figure: Bosch start-stop system layout [Source: Starter Motors and Generators: start/stop technology , Bosch Brochure]



4.2.3.2 Denso: Enhanced Starter Products

Denso has been working on the start-stop technology since early 80's. Three different enhanced starters available from Denso are as follows

a. Advanced Engagement (AE) Starter:

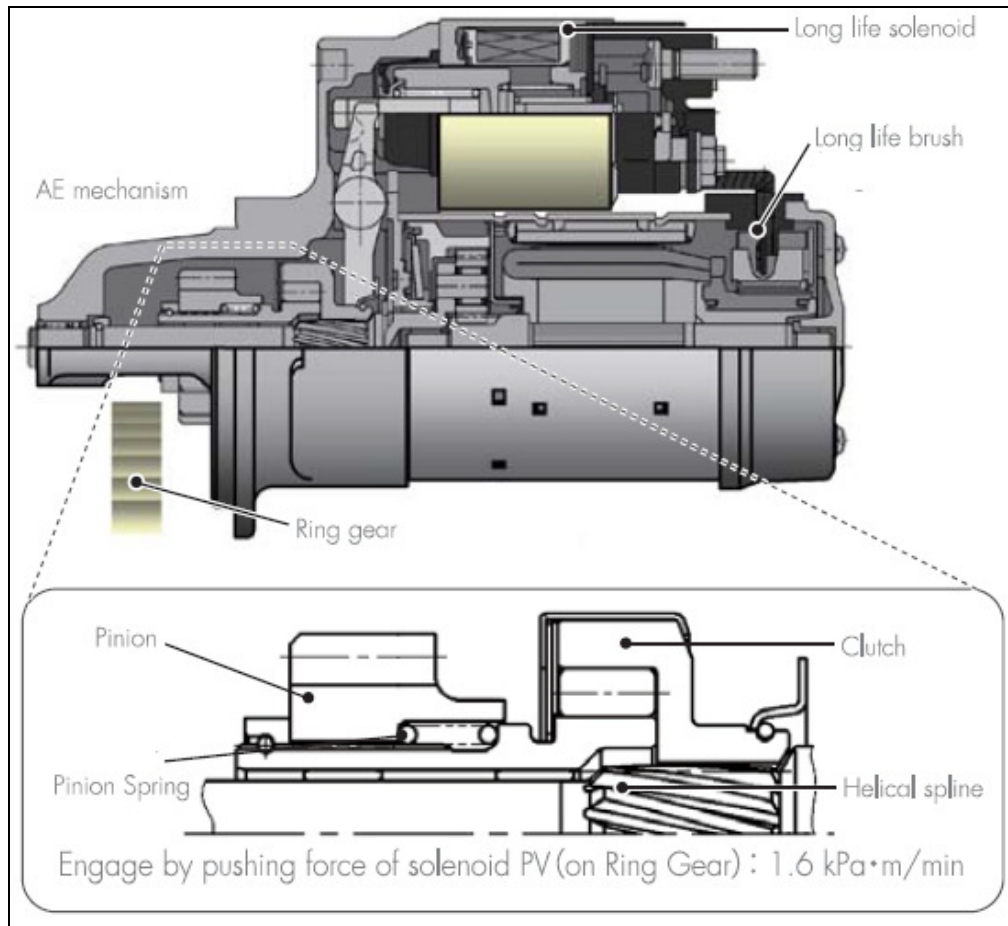

Figure: Schematic diagram of Advanced Engagement (AE) starter [Source: Denso Brochure]

The advanced engagement starter works like a typical starter, which when it is energized shifts pinion forwards, engaging with the flywheel and starts to rotate. Denso claims the advanced starter to have longer life due to development in electrical brushes, which results in up to 10 times higher durability compared to conventional



Start-Stop System Overview

FEV

starter. Denso also claims that development of unique structure and pinion spring mechanism has reduced friction between pinion and ring gear noticeably.

Working principle of start-stop technology is as following. The engine is shutdown by cutting the fuel supply, when vehicle brakes are applied and the vehicle is at standstill and the engine reaches to zero rpm. After this point, the starter is reenergized to re-start the engine by stepping on the accelerator pedal. This system is not capable of change of mind situations as the engine needs to be standing at zero rpm, so there is the some delay in the restart time.

b. Tandem Solenoid (TS) Starter

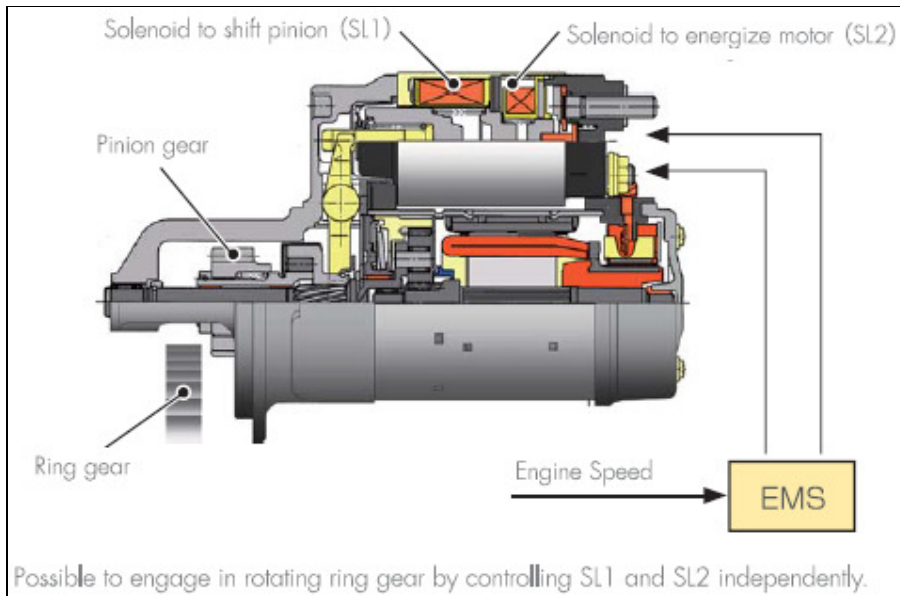

Figure: Schematic diagram of Tandem Solenoid Starter [Source: Denso Brochure]

Denso tandem solenoid consists of co-axial dual solenoid for independent control of the starter’s pinion gear shifting mechanism and motor rotation. One solenoid engages the pinion gear with flywheel ring gear and the other energizes the motor. Special software is used to control the timing and synchronization aspects for pinion gear shifting into the spinning flywheel; possibly with a crankshaft position sensor because as



Start-Stop System Overview

FEV

the flywheel is coming to a stop, its clockwise rotation may be combined with counter-clockwise oscillation, increasing the complexity for engagement strategy. At NAIAS 2011 exhibition Denso has exhibited a sensor that can identify these oscillation and precisely determine crankshaft position. The tandem solenoid starter is capable to adapt for driver change of mind as it does not needs to wait for the engine speed to reach zero speed before restarting and also as it can engage into a moving flywheel, allowing quicker restart times as compared to Advanced Engagement starter. Another salient feature of the tandem solenoid starter is being of same size as that of advanced engagement starter.

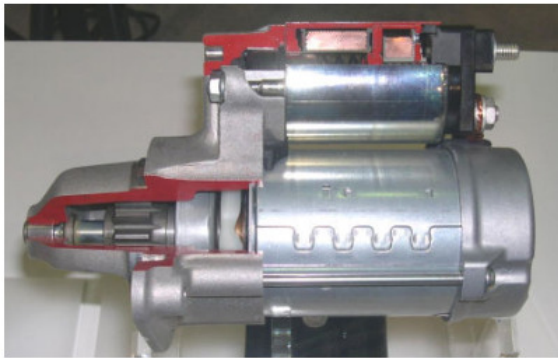

Figure: Dual-Solenoid Denso Starter [Source: <http://ev.sae.org/article/9351>]



c. Permanent Engaged (PE) Starter

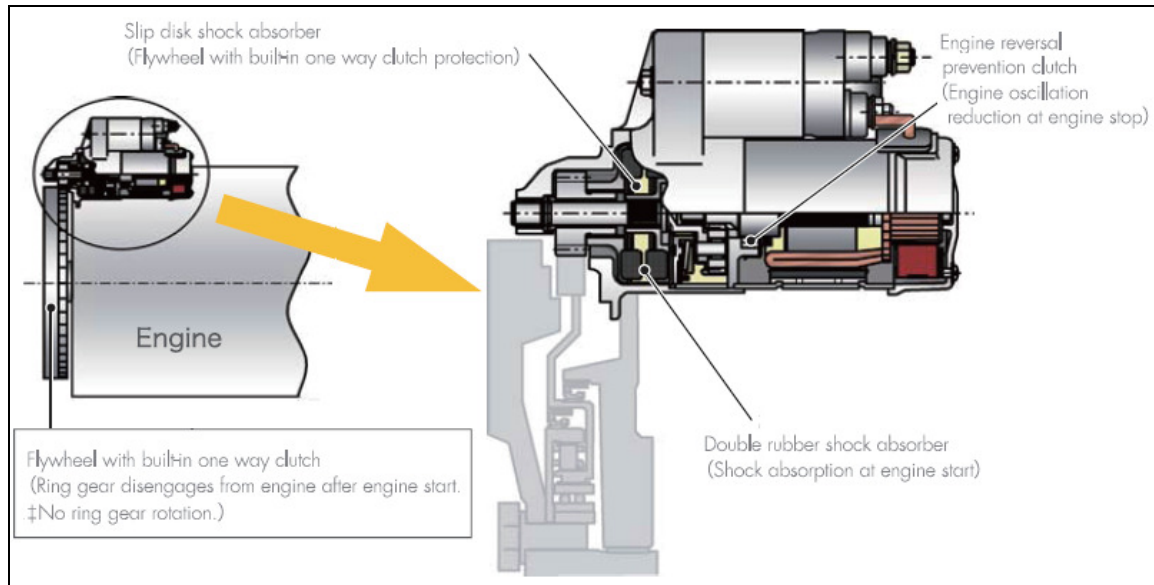

Figure: Schematic diagram of Permanent Engaged (PE) Starter [Source: Denso Brochure]

Permanent engaged Starter is mounted to the engine such that the starter is permanently engaged with the flywheel eliminating the starter's pinion gear shifting mechanism. Restart is accomplished by energizing the motor which re-cranks the engine avoiding the waiting or delay as the starter is already in contact with the flywheel. For permanent engaged starter system the flywheel requires a special clutching mechanism to disconnect it from the engine after engine starts. The permanent engaged starter is also capable to adapt to change of mind situations. As the starter and flywheel gears are permanently connected, dynamics of gear engagement and disengagement as in case of previous systems is not present. These starters are used in Toyota models such as Auris and Yaris sold in Europe since 2009.



4.2.4 In-Market Applications (2012)

Alfa Romeo Mito (Micro/Subcompact Car)

Starter/Generator Type / Supplier:	Integrated Starter-Generator / Bosch	
Functional Scope	Start-Stop, no Recuperation. Motor-Stop If Vehicle Speed is below 3km/h for 0.5s and AccPedal is 0% => ICE off Driver: release clutch, shift to neutral Vehicle must have been faster than 10km/h for next stop. Motor-Start: By pushing the clutch, the engine is started. If Gearbox is in neutral, the engine start is proceeded when the clutch is not completely pressed (faster start). If gear is engaged, the clutch must be pushed completely.	
Battery System	12V – Heavy Duty Battery	
Additional Sensors	<ul style="list-style-type: none"> - Clutch Pedal Sensor (pedal pushed – high, pedal partly pushed – mid, pedal pushed – low) - DC-Voltage stabilizer - 12V-Battery SOC Sensor (Bosch IBS) - Pressure Sensor of power brakes - Neutral Sensor of Gearbox (manual) 	
Modified Components	<ul style="list-style-type: none"> - Body Controller - 12V Battery - stronger Alternator 	
Engine	I4, Gasoline , 1368 cm ³ , Turbo, Multi-Air, 4V, 99kW, Euro 5 5.6l/100km (42 MPG)	
Transmission	5-speed, manual	
SOP	2009	



Start-Stop System Overview

FEV

Alfa Romeo Giulietta (Compact Car)

Starter/Generator Type / Supplier:	Integrated Starter-Generator / Bosch	
Functional Scope	<p>Start-Stop, no Recuperation.</p> <p>Motor-Stop If Vehicle Speed is below 3km/h for 0.5s and AccPedal is 0% => ICE off Driver: release clutch, shift to neutral Vehicle must have been faster than 10km/h for next stop.</p> <p>Motor-Start: By pushing the clutch, the engine is started. If Gearbox is in neutral, the engine start is proceeded when the clutch is not completely pressed (faster start). If gear is engaged, the clutch must be pushed completely.</p>	
Battery System	12V – Heavy Duty Battery	
Additional Sensors	<ul style="list-style-type: none"> - Clutch Pedal Sensor (pedal pushed – high, pedal partly pushed – mid, pedal pushed – low) - DC-Voltage stabilizer - 12V-Battery SOC Sensor (Bosch IBS) - Pressure Sensor of power brakes - Neutral Sensor of Gearbox (manual) 	
Modified Components	<ul style="list-style-type: none"> - Body Controller - 12V Battery - stronger Alternator 	
Engine	<p>I-4 1.4TB, Gasoline, 1368cm³, 88kW (120PS), 5.3-8.4 l/100km (44–28 MPG)</p> <p>I-4 1.4TB, Gasoline, 1368cm³, Turbo, Multi-Air, 16V 125kW (170PS), 4.7-7.9 l/100km (50 – 30 MPG)</p> <p>I-4 1.6 JTDM, Diesel, 1598cm³, 77kW (105PS), 3.7-5.5 l/100km (64 – 43 MPG)</p> <p>I-4 2.0 JTDM, Diesel, 1956cm³, 125kW (170PS), 4.1-5.8 l/100km (57 – 41 MPG)</p>	



Start-Stop System Overview

FEV

Transmission	6-speed, manual	
SOP	2010-11	

Source: <http://www.autoblog.com/2010/04/14/alfa-romeo-giulietta-hits-the-european-market-with-full-details/>

Source: <http://www.autoweek.com/article/20110714/CARREVIEWS/110719944>

Source: http://www.cars-of-europe.com/alfa_romeo/alfa_romeo_giulietta_kt516.shtml



Start-Stop System Overview

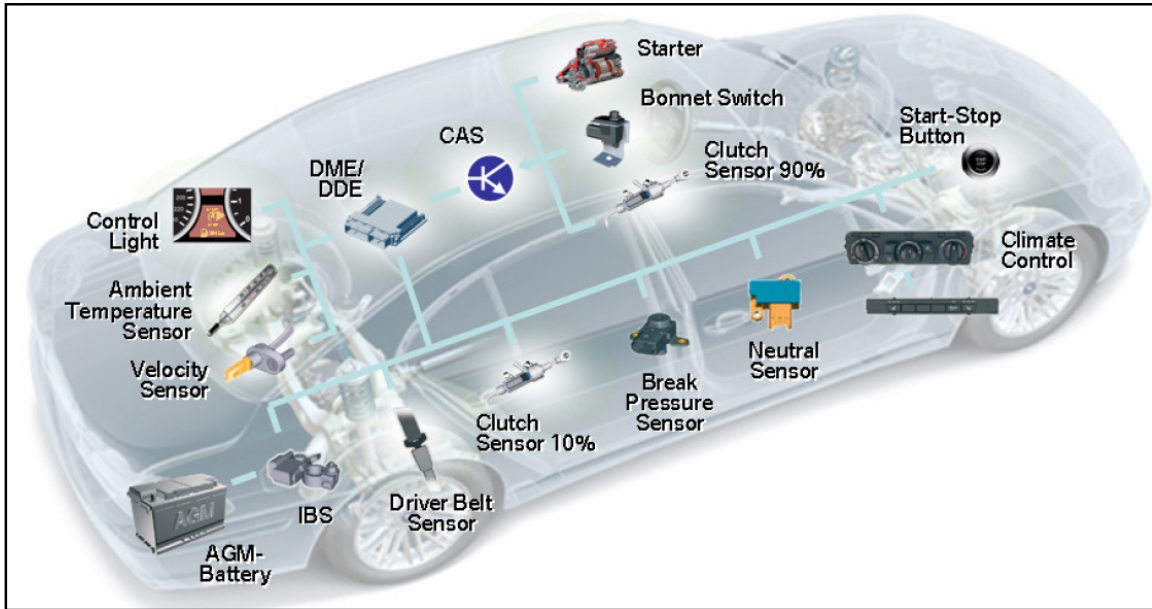

Figure: Required sensors and actuators (BMW Publication)

BMW Efficient Dynamics 1er/3er/Mini

<p>Starter/Generator Type / Supplier:</p>	<p>Enhanced Starter/Enhanced Generator functions for regenerative braking / Bosch system</p>	
<p>Functional Scope</p>	<p>Start-Stop, regenerative braking, visualization of shifting point</p> <p>Motor-Stop If Vehicle Speed is stopped, Brake pedal is pushed and Gears are not engaged (neutral position) => ICE off</p> <p>Motor-Start: By pushing the clutch, the engine is started with short assist of the engine starter</p>	
<p>Battery System</p>	<p>AGM battery 46-90Ah</p>	
<p>Additional Sensors</p>	<ul style="list-style-type: none"> - clutch sensor - neutral gear position sensor - brake pedal sensor 	
<p>Modified Compo-</p>	<ul style="list-style-type: none"> - direct Injection required 	



Start-Stop System Overview

FEV

nents	- Alternator to stop crankshaft in defined position - DC-Voltage stabilizer - Display	
Engine	I4, Gasoline , 1998 cm ³ , DISI, Multi-Air, 4V, 111kW, Euro 5 6,9l/100km (34,1 MPG)	
Transmission	6-speed, manual	
SOP	2009	

BMW 1er 2.0 I (Midsize Car)

Starter/Generator Type / Supplier:	Enhanced Starter/Enhanced Generator functions for regenerative braking / Bosch system	
Functional Scope	<p>Start-Stop, regenerative braking. visualization of shifting point intelligent generator control</p> <p>Motor-Stop If Vehicle Speed is stopped, Brake pedal is pushed and Gears are not engaged (neutral position) and clutch is released => ICE off</p> <p>Motor-Start: By pushing the clutch or releasing the brake (automatic gearbox), the engine is started with short assist of the engine starter. Direct injection on the cylinder in power stroke starts up the engine.</p> <p>Start-Stop doesn't function till</p> <ul style="list-style-type: none"> - the engine temperature is still too low - the difference between the interior temperature and the temperature selected via the air conditioning system is still too great - battery SOC is low or - driver moves the steering wheel <p>Additional function:</p> <ul style="list-style-type: none"> - If necessary for comfort or safety, the control unit will automatically restart 	



Start-Stop System Overview

FEV

	<p>the engine: for example, if the vehicle begins to roll, the battery charge falls too low or condensation forms on the windscreen.</p> <ul style="list-style-type: none"> - The system also recognizes the difference between a temporary stop and the end of the trip. It will not restart the engine if driver's seatbelt is undone, or if the door or bonnet is open 	
Battery System	AGM battery 46-80Ah	
Additional Sensors	<ul style="list-style-type: none"> - clutch sensor - neutral gear position sensor - brake pedal sensor 	
Modified Components	<ul style="list-style-type: none"> - direct Injection required - Alternator to stop crankshaft in defined position - DC-Voltage stabilizer - Display - electrical water pump - flow-rate-controlled oil pump 	
Engine	<p>I-4 1.6i Gasoline, 1995cm³, 90kW (122PS), 5.1-7.9 l/100km (46–30 MPG)</p> <p>I-4 1.8i Gasoline, 1995cm³, 105kW (143PS), 5.1-7.9 l/100km (46–30 MPG)</p> <p>I-4 2.0i Gasoline, 1995cm³, 125kW (170PS), 5.4-8.6 l/100km (44–27 MPG)</p> <p>I-4 1.6d Diesel, 1995cm³, 90kW (122PS), 4.0-5.4 l/100km (59–44 MPG)</p> <p>I-4 1.8d Diesel, 1995cm³, 105kW (143PS), 4.0-5.4 l/100km (59–44 MPG)</p> <p>I-4 2.0d Diesel, 1995cm³, 125kW (170PS), 4.1-5.9 l/100km (57–40 MPG)</p> <p>I-4 2.3d Diesel, 1995cm³, 125kW (170PS), 4.4-6.4 l/100km (53– 37MPG)</p>	
Transmission	6-speed, manual	
SOP	2007	



Start-Stop System Overview

FEV

BMW 3er (Midsize car Car)

Starter/Generator Type / Supplier:	NA	
Functional Scope	Same as in 1er series	
Battery System	XXX	
Additional Sensors	XXX	
Modified Components	Modified starter motor that Bosch is calling a Smart Starter-Motor. flywheel pendulum effect: reduced idle speed and reduced vibrations	
Engine	<p>I-4 1.6i Gasoline, 1599cm³, 90kW (122PS), 5.3-8.1 l/100km (44–29 MPG)</p> <p>I-4 1.8i Gasoline, 1995cm³, 105kW (143PS), 5.3-8.1 l/100km (44–29 MPG)</p> <p>I-4 2.0i Gasoline, 1995cm³, 125kW (170PS), 5.4-8.3 l/100km (44–28 MPG)</p> <p>I-4 1.6d Diesel, 1995cm³, 85kW (116PS), 4.0-5.4 l/100km (59–44 MPG)</p> <p>I-4 1.8d Diesel, 1995cm³, 105kW (143PS), 4.0-5.4 l/100km (59–44 MPG)</p> <p>I-4 2.0d Diesel, 1995cm³, 135kW (184PS), 4.0-5.9 l/100km (59–40 MPG)</p>	
Transmission	6-speed, manual (FWD)	
SOP	2007	



Start-Stop System Overview

FEV

BMW 5er (Luxury Car)

Starter/Generator Type / Supplier:	NA	
Functional Scope	Same as in 1er series	
Battery System	XXX	
Additional Sensors	XXX	
Modified Components	Modified starter motor that Bosch is calling a Smart Starter-Motor.	
Engine	<p>I-4 2.0i Gasoline, 1997cm³, 135kW (184PS), 5.5-8.9 l/100km (43–26 MPG)</p> <p>I-4 3.0i Gasoline, 2979cm³, 225kW (306PS), 6.3-11.1 l/100km (37–21 MPG)</p> <p>I-4 2.0d Diesel, 1995cm³, 90kW (135PS), 4.2-5.7 l/100km (56–41 MPG)</p> <p>I-4 1.8d Diesel, 1995cm³, 105kW (143PS), 4.0-5.4 l/100km (59–44 MPG)</p> <p>I-4 2.0d Diesel, 1995cm³, 135kW (184PS), 4.0-5.9 l/100km (59–40 MPG)</p>	
Transmission	6-speed, manual (FWD)	
SOP	2009-10	



Start-Stop System Overview

FEV

BMW 6er (Sport)

Starter/Generator Type / Supplier:	NA	
Functional Scope	Same as in 1er series	
Battery System	XXX	
Additional Sensors	XXX	
Modified Components	Modified starter motor that Bosch is calling a Smart Starter-Motor.	
Engine	<p>I-6 3.0i Gasoline, 2979cm³, 235kW (320PS), 6.0-10.3 l/100km (39–23 MPG)</p> <p>V-8 5.0i Gasoline, 4395cm³, 300kW (407PS), 7.7-15.4 l/100km (31–15 MPG)</p> <p>I-6 3.0d Diesel, 2993cm³, 203kW (313PS), 4.8-6.6 l/100km (49–36 MPG)</p>	
Transmission	8-speed, automatic (FWD)	
SOP	2009-10	



Start-Stop System Overview

FEV

BMW X1 (SUV)

Starter/Generator Type / Supplier:	NA	
Functional Scope	Same as in 1er series	
Battery System	XXX	
Additional Sensors	XXX	
Modified Components	Modified starter motor that Bosch is calling a Smart Starter-Motor.	
Engine	<p>I-4 1.8i Gasoline, 1995cm³, 110kW (150PS), 6.4-11.3 l/100km (37–21MPG)</p> <p>I-4 2.0i Gasoline, 1997cm³, 135kW (184PS), 6.5-9.7 l/100km (36–24MPG)</p> <p>I-4 1.8d Diesel, 1995cm³, 105kW (143PS), 4.7-6.1 l/100km (50–39MPG)</p> <p>I-4 2.0d Diesel, 1997cm³, 130kW (177PS), 5.1-7.0 l/100km (46–34MPG)</p>	
Transmission	6-speed, manual (FWD)	
SOP	2009-10	



Start-Stop System Overview

FEV

BMW X3 (SUV)

Starter/Generator Type / Supplier:	NA	
Functional Scope	Same as in 1er series	
Battery System	XXX	
Additional Sensors	XXX	
Modified Components	Modified starter motor that Bosch is calling a Smart Starter-Motor.	
Engine	I-4 2.0i Gasoline , 1997cm ³ , 135kW (184PS), 6.7-9.9 l/100km (39–23 MPG) 6-speed, manual transmission	
	I-6 3.0i Gasoline , 2979cm ³ , 225kW (306PS), 7.4-11.2 l/100km (31–15 MPG) 8-speed, automatic transmission	
	I-4 2.0d Diesel , 1995cm ³ , 135kW (184PS), 5.0-6.7 l/100km (49–36 MPG) 6-speed, manual transmission	
	I-6 3.0d Diesel , 2993cm ³ , 190kW (258PS), 5.6-6.8 l/100km (31–15 MPG) 8-speed, automatic transmission	
Transmission	Manual / Automatic	
SOP	2009-10	



Start-Stop System Overview

FEV

Fiat 500 / 500 c (Micro/Subcompact Car)

Starter/Generator Type / Supplier:	Enhanced Starter/Generator/ Bosch (Intelligent Stop & Go, ISG)	
Functional Scope		
Battery System	Heavy Duty Battery	
Additional Sensors	<ul style="list-style-type: none"> - Clutch Pedal Sensor (pedal pushed – high, pedal partly pushed – mid, pedal pushed – low) - DC-Voltage stabilizer - 12V-Battery SOC Sensor (Bosch IBS) - Pressure Sensor of power brakes - Neutral Sensor of Gearbox (manual) 	
Modified Components	<ul style="list-style-type: none"> - enhanced flywheel - enhanced starter - Heavy Duty 12V Battery - bigger Generator (Alternator) - DC Voltage Stabilizer - body controller 	
Engine	<p>I4-1.2 8V, Gasoline, DISI, Turbo, MultiAir 1242cm³, 51kW (69PS), 4.3-6.4l/100km (55-37MPG)</p> <p>I4-1.4 16V, Gasoline, DISI, Turbo, MultiAir 1368cm³, 73kW (100PS), 5.1-7.7l/100km (46-30MPG)</p> <p>I4-1.3, 16V, Diesel, Multijet, 1248cm³, 70kW (95PS), 3.3-5.0l/100km (71-47MPG)</p>	
Transmission	5-speed, manual	
SOP	2010	



Start-Stop System Overview

FEV

Fiat Punto / Punto Evo (Compact Car)

Starter/Generator Type / Supplier:	Enhanced Starter/Generator/ Bosch (Intelligent Stop & Go, ISG)	
Functional Scope		
Battery System	Similar to Fiat 500	
Additional Sensors	Similar to Fiat 500	
Modified Components	Similar to Fiat 500	
Engine	<p>I4-1.2 8V, Gasoline, MultiAir 1242cm³, 51kW (69PS), Euro5 4.3-6.4l/100km (55-37MPG)</p> <p>I4-1.4 8V, Gasoline, MultiAir 1368cm³, 57kW (77PS), Euro5</p> <p>I4-1.4 16V, Gasoline, MultiAir 1368cm³, 73kW (100PS), Euro5 5.1-7.7l/100km (46-30MPG)</p> <p>I4-1.3, 16V, Diesel, Multijet, 1248cm³, 70kW (95PS), 3.3-5.0l/100km (71-47MPG)</p> <p>I4-1.6, 16V, Diesel, Multijet, 1598cm³, 70kW (95PS), Euro5</p>	
Transmission	5-speed, manual	
SOP	2011	



Start-Stop System Overview

FEV

Fiat Qubo (Van)

Starter/Generator Type / Supplier:	Enhanced Starter/Generator/ Bosch (Intelligent Stop & Go, ISG)	
Functional Scope		
Battery System	Similar to Fiat 500	
Additional Sensors	Similar to Fiat 500	
Modified Components	Similar to Fiat 500	
Engine	I4-1.3, 16V, Diesel , Multijet, 1248cm ³ , 70kW (95PS), Euro5 3.6-4.9l/100km (71-47MPG)	
Transmission	5-speed, manual	
SOP	2011	

Fiat Doblo (Van)

Starter/Generator Type / Supplier:	Enhanced Starter/Generator/ Bosch (Intelligent Stop & Go, ISG)	
Functional Scope		
Battery System	Similar to Fiat 500	
Additional Sensors	Similar to Fiat 500	
Modified Components	Similar to Fiat 500	
Engine	I4-1.4, 16V, Gasoline , Multiair, 1368cm ³ , 70kW (95PS), Euro5 5.9-9.3l/100km (40-25MPG) I4-1.6, 16V, Diesel , Multijet, 1598cm ³ , 66kW (90PS), Euro5 4.7-6.1l/100km (50-38MPG) I4-1.6, 16V, Diesel , Multijet, 1598cm ³ , 77kW (105PS), Euro5 4.7-6.1l/100km (50-38MPG) I4-2.0, 16V, Diesel , Multijet, 1598cm ³ , 99kW (135PS), Euro5 5.1-6.7l/100km (46-35MPG)	
Transmission	5-speed, manual	
SOP	2011	

Source: http://www.fiat.de/cgi-in/pbrand.dli/FIAT_GERMANY/section/section.jsp?BV_SessionID=@@@@0350527162.1321456053@@@&BV_EngineID=cccfadfdmgjjmkcefecejgdfkhdjfh.0&contentOID=1074945912

In-market Application of Start-Stop Systems in European Market

50



Start-Stop System Overview

FEV



<http://www.fiat.co.uk/showroom/flat-bravo-compare/?id=3728&vars=198,198,198&ses=true&hash=showroom/bravo/compare>



Start-Stop System Overview

FEV

Ford Ka (Micro/Subcompact Car)

Starter/Generator Type / Supplier:		
Functional Scope		
Battery System		
Additional Sensors		
Modified Components	Enhanced 12V battery and upgraded starter motor	
Engine	I4- 1,2l EcoBoost, Gasoline , 1242cm ³ , 51kW (69 PS), Euro5, 4,9l/100km (48MPG) I4- 1,3l- TDCi, Diesel , 1248cm ³ , 55kW (75 PS), Euro5, 3.7-4,9l/100km (63-57MPG)	
Transmission	5-speed, manual	
SOP	2010	

Ford Focus (Compact Car)

Starter/Generator Type / Supplier:		
Functional Scope		
Battery System		
Additional Sensors		
Modified Components	Enhanced 12V battery and upgraded starter motor	
Engine	I4- 1.6l-EcoBoost, Gasoline , 1596cm ³ , 110kW (150 PS), 5.0-7.7l/100km (47-31MPG) I4- 1,6l-Duratorq-TDCi, Diesel , 1560cm ³ , 70kW (95 PS), Euro5, 3.7-5.1l/100km (63-46MPG)	
Transmission	6-speed, manual	
SOP	2010	



Start-Stop System Overview

FEV

Ford C-Max (Van/MiniVan)

Starter/Generator Type / Supplier:		
Functional Scope		
Battery System		
Additional Sensors		
Modified Components	Enhanced 12V battery and upgraded starter motor	
Engine	I4- 1.6l-EcoBoost, Gasoline , 1596cm ³ , 110kW (150 PS), 5.3-8.1l/100km (44-29MPG) I4- 1.6l-EcoBoost, Gasoline , 1596cm ³ , 134kW (182 PS), 5.3-8.1l/100km (44-29MPG)	
Transmission	6-speed, manual	
SOP	2011	

Ford Mondeo (Mid size Car)

Starter/Generator Type / Supplier:		
Functional Scope		
Battery System		
Additional Sensors		
Modified Components	Enhanced 12V battery and upgraded starter motor	
Engine	I4- 1.6l-EcoBoost, Gasoline , 1596cm ³ , 118kW (160 PS), 5.4-8.2l/100km (43-28MPG)	
Transmission	6-speed, manual	
SOP	2011	



Start-Stop System Overview

FEV

Ford S-Max (Van)

Starter/Generator Type / Supplier:		
Functional Scope		
Battery System		
Additional Sensors		
Modified Components	Enhanced 12V battery and upgraded starter motor	
Engine	I4- 1.6l-EcoBoost, Gasoline , 1596cm ³ , 118kW (160 PS), 5.4-8.2l/100km (43-28MPG)	
Transmission	6-speed, manual	
SOP	2011	

Ford Galaxy (Van)

Starter/Generator Type / Supplier:		
Functional Scope		
Battery System		
Additional Sensors		
Modified Components	Enhanced 12V battery and upgraded starter motor	
Engine	I4- 1.6l-EcoBoost, Gasoline , 1596cm ³ , 118kW (160 PS), 6.1-9.1l/100km (38-26MPG) I4- 1,6l-Duratorq-TDCi, Diesel , 1560cm ³ , 85kW (11 PS), Euro5, 4.9-5.9l/100km (48-40MPG)	
Transmission	6-speed, manual	
SOP	2011	



Start-Stop System Overview

FEV

Jaguar XF (Sports Car)

Starter/Generator Type / Supplier:	Tandem Solenoid Starter	
Functional Scope		
Battery System		
Additional Sensors		
Modified Components		
Engine	I4- 2.2l- AJ-i4D Diesel , 2179cm ³ , 140kW (190 PS), 4.8-6.6l/100km (49- 36MPG)	
Transmission	8-speed, automatic	
SOP	2012-13	

Source: <http://www.topcar.co.za/first-drives/articles/2012-jaguar-xf-review>

Kia Cee'd (Compact Car)

Starter/Generator Type / Supplier:	Enhanced Starter/ Bosch (Intelligent Stop & Go, ISG)	
Functional Scope	Start-Stop, no Recuperation	
Battery System	12V Battery, Absorbent Glass Mat (AGM-Battery, Varta)	
Additional Sensors	<ul style="list-style-type: none"> - 12V-Battery SOC Sensor (Bosch IBS) - DC/DC-Converter - Power Brakes Vacuum Sensor - Neutral position sensor of gear shifter 	
Modified Components	<ul style="list-style-type: none"> - 12V Battery - stronger Alternator Existing Sensors used for Start-Stop <ul style="list-style-type: none"> - Clutch sensor - Safety belt sensor (driver) - Door switch (driver) - hood switch 	
Engine	I4-16V, Gasoline , MPI, CVVT, 1591cm ³ , 90kW, Euro5, 5,8-6,1l/100km (38-40 MPG)	
Transmission	5-speed Manual	
SOP	2009	



Start-Stop System Overview

FEV

Kia Venga (Compact Car)

Starter/Generator Type / Supplier:	Enhanced Starter / Bosch (Idle Stop and Go, ISG)	
Functional Scope	Start-Stop, no Recuperation	
Battery System	12V Battery, Absorbent Glass Mat (AGM-Battery, Varta)	
Additional Sensors	<ul style="list-style-type: none"> - 12V-Battery SOC Sensor (Bosch IBS) - DC/DC-Converter - Power Brakes Vacuum Sensor - Neutral position sensor of gear shifter 	
Modified Components	<ul style="list-style-type: none"> - 12V Battery - stronger Alternator Existing Sensors used for Start-Stop <ul style="list-style-type: none"> - Clutch sensor - Safety belt sensor (driver) - Door switch (driver) - hood switch 	
Engine	I4, Diesel , Common Rail Direct Injection (CRDi), 1.582ccm ³ , 94kW, Euro 5, 4.5l/100km (52 MPG)	
Transmission	6-Speed, Manual	
SOP	2009	



Start-Stop System Overview

FEV

LandRover eD4 e (SUV)

Starter/Generator Type / Supplier:	Enhanced Starter/Generator / Denso	
Functional Scope	Start-Stop	
Battery System	12V Battery, Absorbent Glass Mat (AGM-Battery, Varta)	
Additional Sensors	<ul style="list-style-type: none"> - Clutch Pedal Sensor - DC-Voltage stabilizer - 12V-Battery SOC Sensor (Bosch IBS) - Vacuum Sensor of power brakes - Neutral Sensor of Gearbox (manual) - electric water pump 	
Modified Components	<ul style="list-style-type: none"> - Body Controller - 12V Battery - stronger Alternator 	
Engine	2,2l Diesel , 2179 ccm, 110kW, fuel consumption, inner city 7,1l, outer city 5,4l, combined 6,0l, 158 g CO ₂	
Transmission	6-speed, manual	
SOP	20011	



Start-Stop System Overview

FEV

MINI Cooper S (Micro/Subcompact Car)

Starter/Generator Type / Supplier:	Enhanced Starter/Generator / Bosch (Intelligent Start & Go, ISG)	
Functional Scope	Start-Stop	
Battery System	12V Battery, Absorbent Glass Mat (AGM-Battery, Varta)	
Additional Sensors	<ul style="list-style-type: none"> - Clutch Pedal Sensor - DC-Voltage stabilizer - 12V-Battery SOC Sensor (Bosch IBS) - Vacuum Sensor of power brakes - Neutral Sensor of Gearbox (manual) 	
Modified Components	<ul style="list-style-type: none"> - Body Controller - 12V Battery - stronger Alternator 	
Engine	I4-16V, Gasoline , 1598 cm ³ , Turbo, DISI, Valvetronic, 135kW, Euro 5 5.8l/100km (40 MPG)	
Transmission	6-speed, manual	
SOP	2006	



Start-Stop System Overview

FEV

Opel Agila (Micro/Subcompact Car)

Starter/Generator Type / Supplier:	Enhanced Starter/Generator	
Functional Scope	Start-Stop	
Battery System	12V Battery, Absorbent Glass Mat (AGM-Battery, Varta)	
Additional Sensors	<ul style="list-style-type: none"> - Display adaptation with Autostop - Clutch Pedal Sensor - ECO tip switch - Neutral Sensor of Gearbox (manual) - optimized climate control with additional water pump for heating system - DC-Voltage stabilizer - 12V-Battery Current Sensor - Vacuum Sensor of power brakes - electric water pump - hood open detection sensor - vacuum brake pressure sensor - door open detection sensor - belt detection for driver 	
Modified Components	<ul style="list-style-type: none"> - Body Controller - 12V Battery - stronger Starter - climate control - generator control 	
Engine	<p>1,0l Gasoline, 996 ccm, 50 kW, Euro 5, Inner city 5,3l, outer city 4,2l, combined 4,6l, 106 g CO₂</p> <p>1,2l Gasoline 1242 ccm, 69 kW, Euro 5, Inner city 5,9l, outer city 4,5l, combined 5,0l, 115 g CO₂</p>	
Transmission	5-speed, manual	
SOP	2010	



Start-Stop System Overview

FEV

Opel Astra (Midsize Car)

Starter/Generator Type / Supplier:	Enhanced Starter/Generator	
Functional Scope	Start-Stop	
Battery System	12V Battery, Absorbent Glass Mat (AGM-Battery, Varta)	
Additional Sensors	<ul style="list-style-type: none"> - Display adaptation with Autostop - Clutch Pedal Sensor - ECO tip switch - Neutral Sensor of Gearbox (manual) - optimized climate control with additional water pump for heating system - DC-Voltage stabilizer - 12V-Battery Current Sensor - Vacuum Sensor of power brakes - electric water pump - hood open detection sensor - vacuum brake pressure sensor - door open detection sensor - belt detection for driver 	
Modified Components	<ul style="list-style-type: none"> - Body Controller - 12V Battery - stronger Starter - climate control - generator control 	
Engine	<p>1,4l, Gasoline, 1398 ccm, 74 kW, Euro 5, Inner city 6,7l, outer city 4,5l, combined 5,3l, 124 g CO₂</p> <p>1,6l, Gasoline, 1598 ccm, 85 kW, Euro 5, Inner city 7,8l, outer city 4,8l, combined 5,9l, 139 g CO₂</p> <p>1,4l, Gasoline, Turbo, 1364 ccm, 88 kW, Euro 5, Inner city 7,1l, outer city 4,6l, combined 5,5l, 129 g CO₂</p> <p>1,3l, Diesel CDTI, 1248 ccm, 70 kW, Euro 5, Inner city 4,7l, outer city 3,5l, combined 3,9l, 104 g CO₂</p> <p>1,7l, Diesel CDTI, 1686 ccm, 81 kW, Euro 5, Inner city 4,3l, outer city 3,4l, combined 3,7l, 99 g CO₂</p>	



Start-Stop System Overview



	1,7l, Diesel CDTI, 1686 ccm, 96 kW, Euro 5, Inner city 5,1l, outer city 3,9l, combined 4,3l, 114 g CO ₂	
	2,0l, Diesel CDTI, 1956 ccm, 121 kW, Euro 5, Inner city 5,4l, outer city 4,0l, combined 4,5l, 119 g CO ₂	
Transmission	5-speed, manual, 6 speed manual	
SOP	2009	



Start-Stop System Overview

FEV

Opel Combo (Van)

Starter/Generator Type / Supplier:	Enhanced Starter/Generator	
Functional Scope	Start-Stop	
Battery System	12V Battery, Absorbent Glass Mat (AGM-Battery, Varta)	
Additional Sensors	<ul style="list-style-type: none"> - Display adaptation with Autostop - Clutch Pedal Sensor - ECO tip switch - Neutral Sensor of Gearbox (manual) - optimized climate control with additional water pump for heating system - DC-Voltage stabilizer - 12V-Battery Current Sensor - Vacuum Sensor of power brakes - electric water pump - hood open detection sensor - vacuum brake pressure sensor - door open detection sensor - belt detection for driver 	
Modified Components	<ul style="list-style-type: none"> - Body Controller - 12V Battery - stronger Starter - climate control - generator control 	
Engine	<p>1,4l, Gasoline, 1364 ccm, 70 kW, Euro 5, Inner city 9,5l-9,3l, outer city 6,1l-5,9l, combined 7,4l-7,2l, 171 g – 166 g CO₂</p> <p>1,6l, Diesel, 1598 ccm, 66 kW, Euro 5, Inner city 6,3l-6,1l, outer city 5,2l-4,7l, combined 5,6l-5,2l, 148 g – 138 g CO₂</p> <p>1,4l, Gasoline, 1346 ccm, 70 kW, Euro 5, Inner city 9,5l-9,3l, outer city 6,1l-5,9l, combined 7,4l-7,2l, 171 g – 166 g CO₂</p>	
Transmission	5-speed, manual / 6-speed manual / 5-speed easytronic	
SOP	2009	



Start-Stop System Overview

FEV

Opel Corsa (Compact Car)

Starter/Generator Type / Supplier:	Enhanced Starter/Generator	
Functional Scope	Start-Stop	
Battery System	12V Battery, Absorbent Glass Mat (AGM-Battery, Varta)	
Additional Sensors	<ul style="list-style-type: none"> - Display adaptation with Autostop - Clutch Pedal Sensor - ECO tip switch - Neutral Sensor of Gearbox (manual) - optimized climate control with additional water pump for heating system - DC-Voltage stabilizer - 12V-Battery Current Sensor - Vacuum Sensor of power brakes - electric water pump - hood open detection sensor - vacuum brake pressure sensor - door open detection sensor - belt detection for driver 	
Modified Components	<ul style="list-style-type: none"> - Body Controller - 12V Battery - stronger Starter - climate control - generator control 	
Engine	<p>1,2l, Gasoline, 1364 ccm, 51 kW, Euro 5, Inner city 6,4l, outer city 4,3l, combined 5,1l, 119 g CO₂</p> <p>1,4l, Gasoline, 1398 ccm, 74 kW, Euro 5, Inner city 6,6l, outer city 4,5l, combined 5,3l, 124 g CO₂</p> <p>1,4l, Gasoline, 1398 ccm, 64 kW, Euro 5, Inner city 6,6l, outer city 4,5l, combined 5,3l, 124 g CO₂</p> <p>1,3l CDTI, Diesel, 1248 ccm, 55 kW, Euro 5, Inner city 4,8l, outer city 3,5l, combined 4,0l, 105 g CO₂</p> <p>1,3l, Gasoline, 1248 ccm, 70 kW, Euro 5, Inner city 4,2l, outer city 3,1l, combined 3,5l, 94 g CO₂</p>	



Transmission	5-speed, manual	
SOP	2006 - today	



Start-Stop System Overview

FEV

Opel Insignia (Midsize Car)

Starter/Generator Type / Supplier:	Enhanced Starter/Generator	
Functional Scope	Start-Stop	
Battery System	12V Battery, Absorbent Glass Mat (AGM-Battery, Varta)	
Additional Sensors	<ul style="list-style-type: none"> - Display adaptation with Autostop - Clutch Pedal Sensor - ECO tip switch - Neutral Sensor of Gearbox (manual) - optimized climate control with additional water pump for heating system - DC-Voltage stabilizer - 12V-Battery Current Sensor - Vacuum Sensor of power brakes - electric water pump - hood open detection sensor - vacuum brake pressure sensor - door open detection sensor - belt detection for driver 	
Modified Components	<ul style="list-style-type: none"> - Body Controller - 12V Battery - stronger Starter - climate control - generator control 	
Engine	<p>1,4l, Gasoline, Turbo, 1364 ccm, 103 kW, Euro 5, Inner city 7,5l, outer city 4,7l, combined 5,7l, 134 g CO₂</p> <p>2,0l, Gasoline, Turbo, 1998 ccm, 162 kW, Euro 5, Inner city 10,9l, outer city 5,7l, combined 8,4l, 179 g CO₂</p> <p>2,0l, Gasoline, Turbo, 1998 ccm, 184 kW, Euro 5, Inner city 11,6l, outer city 6,5l, combined 8,4l, 197 g CO₂</p> <p>2,0l, Diesel, CDTI, 1956 ccm, 96 kW, Euro 5, Inner city 5,3l, outer city 3,9l, combined 4,4l, 116 g CO₂</p> <p>2,0l, Diesel, CDTI, 1956 ccm, 118 kW, Euro 5, Inner city 5,4l, outer city 3,7l, combined 4,3l, 115 g CO₂</p>	



Start-Stop System Overview



	2,0l, Diesel , Biturbo, CDTI, 1956 ccm, 143 kW, Euro 5, Inner city 6,3l, outer city 4,2l, combined 5,0l, 132 g CO ₂	
Transmission	6-speed, manual / 6 speed automatik	
SOP	2008	



Start-Stop System Overview

FEV

Opel Meriva (Van)

Starter/Generator Type / Supplier:	Enhanced Starter/Generator	
Functional Scope	Start-Stop	
Battery System	12V Battery, Absorbent Glass Mat (AGM-Battery, Varta)	
Additional Sensors	<ul style="list-style-type: none"> - Display adaptation with Autostop - Clutch Pedal Sensor - ECO tip switch - Neutral Sensor of Gearbox (manual) - optimized climate control with additional water pump for heating system - DC-Voltage stabilizer - 12V-Battery Current Sensor - Vacuum Sensor of power brakes - electric water pump - hood open detection sensor - vacuum brake pressure sensor - door open detection sensor - belt detection for driver 	
Modified Components	<ul style="list-style-type: none"> - Body Controller - 12V Battery - stronger Starter - climate control - generator control 	
Engine	<p>1,4l, Gasoline, 1398 ccm, 74 kW, Euro 5, Inner city 6,9l, outer city 5,0l, combined 5,7l, 134 g CO₂</p> <p>1,4l, Gasoline, 1364 ccm, 88 kW, Euro 5, Inner city 7,2l, outer city 4,8l, combined 5,7l, 134 g CO₂</p> <p>1,4l, Diesel, CDTI, 1248 ccm, 70 kW, Euro 5, Inner city 4,8l, outer city 3,7l, combined 4,1l, 109 g CO₂</p>	
Transmission	5-speed manual, 6-speed manual	
SOP	2010	



Start-Stop System Overview

FEV

Opel Zafira Tourer (Van)

Starter/Generator Type / Supplier:	Enhanced Starter/Generator	
Functional Scope	Start-Stop	
Battery System	12V Battery, Absorbent Glass Mat (AGM-Battery, Varta)	
Additional Sensors	<ul style="list-style-type: none"> - Display adaptation with Autostop - Clutch Pedal Sensor - ECO tip switch - Neutral Sensor of Gearbox (manual) - optimized climate control with additional water pump for heating system - DC-Voltage stabilizer - 12V-Battery Current Sensor - Vacuum Sensor of power brakes - electric water pump - hood open detection sensor - vacuum brake pressure sensor - door open detection sensor - belt detection for driver 	
Modified Components	<ul style="list-style-type: none"> - Body Controller - 12V Battery - stronger Starter - climate control - generator control 	
Engine	<p>1,4l, Gasoline, Turbo, 1364 ccm, 88 kW, Euro 5, Inner city 8,1l, outer city 5,3l, combined 6,3l, 148 g CO₂</p> <p>1,4l, Gasoline, Turbo, 1364 ccm, 103 kW, Euro 5, Inner city 8,1l, outer city 5,3l, combined 6,3l, 148 g CO₂</p> <p>2,0l, Diesel, CDTI, 1956 ccm, 96 kW, Euro 5, Inner city 5,5l, outer city 4,0l, combined 4,5l, 119 g CO₂</p> <p>2,0l, Diesel, CDTI, 1956 ccm, 121 kW, Euro 5, Inner city 6,2l, outer city 4,6l, combined 5,2l, 137 g CO₂</p>	
Transmission	6-speed, manual	
SOP		



Start-Stop System Overview

FEV

Skoda Fabia (Compact Car)

Starter/Generator Type / Supplier:	Enhanced Starter/Generator (similar to VW technology)	
Functional Scope		
Battery System		
Additional Sensors		
Modified Components		
Engine	<p>I-3 1.2 MPI Gasoline, 1198cm³, 51kW (70PS), 4.3-6.8 l/100km (55 – 35MPG)</p> <p>I-4 1.2 TSI Gasoline, 1197cm³, 77kW (105PS), 4.4-6.3 l/100km (53 – 37MPG)</p> <p>I-3 1.2 TDI Diesel, 1199cm³, 55kW (75PS), 3.0-4.1 l/100km (78 – 57MPG)</p> <p>I-4 1.6 TDI Diesel, 1598cm³, 66kW (90PS), 3.4-4.5 l/100km (69 – 52MPG)</p>	
Transmission	5 - speed, manual (FWD)	
SOP	2010-11	



Start-Stop System Overview

FEV

Skoda Roomster (Van / Mini Van)

Starter/Generator Type / Supplier:	Enhanced Starter/Generator (similar to VW technology)	
Functional Scope		
Battery System		
Additional Sensors		
Modified Components		
Engine	I-4 1.2 TSI Gasoline , 1197cm ³ , 77kW (105PS), 4.6-6.6 l/100km (21 – 36MPG) I-3 1.2 TDI Diesel , 1199cm ³ , 55kW (75PS), 3.7-5.0 l/100km (64 – 47MPG)	
Transmission	5 - speed, manual (FWD)	
SOP	2010-11	

Skoda Octavia (Midsize Car)

Starter/Generator Type / Supplier:	Enhanced Starter/Generator (similar to VW technology)	
Functional Scope		
Battery System		
Additional Sensors		
Modified Components		
Engine	I-4 1.4 TSI Gasoline , 1390cm ³ , 90kW (123PS), 4.9-7.2 l/100km (48 – 33MPG) I-4 1.6 TDI Diesel , 1598cm ³ , 77kW (105PS), 3.4-4.7 l/100km (69 – 50MPG)	
Transmission	5 - speed, manual (FWD)	
SOP	2010-11	



Start-Stop System Overview

FEV

Skoda Superb (Midsize Car)

Starter/Generator Type / Supplier:	Enhanced Starter/Generator (similar to VW technology)	
Functional Scope		
Battery System		
Additional Sensors		
Modified Components		
Engine	I-4 1.4 TSI Gasoline , 1390cm ³ , 92kW (125PS), 4.9-7.8 l/100km (48 – 30MPG) I-4 1.6 TDI Diesel , 1598cm ³ , 77kW (105PS), 3.8-5.4 l/100km (62 – 44MPG)	
Transmission	5 - speed, manual (FWD)	
SOP	2010-11	



Start-Stop System Overview

FEV

Skoda Yeti (SUV)

Starter/Generator Type / Supplier:	Enhanced Starter/Generator (similar to VW technology)	
Functional Scope		
Battery System		
Additional Sensors		
Modified Components		
Engine	<p>I-4 1.4 TSI Gasoline, 1390cm³, 90kW (123PS), 5.5-7.9 l/100km (43 – 30MPG)</p> <p>I-4 1.6 TDI Diesel, 1598cm³, 77kW (105PS), 4.2-5.2 l/100km (56 – 45MPG)</p> <p>I-4 2.0 TDI Diesel, 1968cm³, 103kW (140PS), 4.5-6.1 l/100km (53 – 39MPG)</p>	
Transmission	5 - speed, manual (FWD)	
SOP	2010-11	



Start-Stop System Overview

FEV

Volkswagen Golf (Compact Car)

Starter/Generator Type / Supplier:	Enhanced Starter/Generator	
Functional Scope	Start-Stop and regenerative braking	
Battery System	12V Battery, Absorbent Glass Mat (AGM-Battery)	
Additional Sensors	<ul style="list-style-type: none"> - Display adaptation with Autostop - Clutch Pedal Sensor (for manual transmission) - Neutral Sensor of Gearbox (manual) - 12V-Battery Current Sensor - Vacuum Sensor of power brakes - door open detection sensor - belt detection for driver 	
Modified Components	<ul style="list-style-type: none"> - Body Controller - 12V Battery - stronger Starter - climate control - intelligent generator control - tires - drag coefficient (by modifications of ride height, partially closed air intake ducts) 	
Engine	<p>1,2l Turbo Gasoline, 4 cylinder, 77 kW, fuel consumption 6,5l inner city NEDC, 4,3l outer city, 5,2l combined, 121 g CO₂</p> <p>1,6l Diesel with Blue Motion, 4 cylinder, 77 kW, fuel consumption 5,2l inner city, 3,5l outer city, 4,1l combined, 107 g CO₂</p> <p>With DSG 4,7l inner city, 3,9l outer city, 4,2l combined, 109 g CO₂</p> <p>1,6l Diesel, 4 cylinder, 77 kW, fuel consumption, 4,7l inner city, 3,4l outer city, 3,8l combined, 99 g CO₂</p> <p>2,0l Diesel, 4 cylinder, 103 kW, fuel consumption 4,1l outer city, 3,0l inner city, 3,4l combined 89 g CO₂</p>	



Start-Stop System Overview





	1,6l Diesel , 4 cylinder, 66 kW, fuel consumption 4,6l inner city, 3,2l outer city, 3,7l combined, 96 g CO ₂	
Transmission	5-speed, manual	
SOP	2009	



Start-Stop System Overview

Volkswagen Passat (Midsize Car)

Starter/Generator Type / Supplier:	Enhanced Starter/Generator	
Functional Scope	Start-Stop and regenerative braking	
Battery System	12V Battery, Absorbent Glass Mat (AGM-Battery, Varta)	
Additional Sensors	<ul style="list-style-type: none"> - Display adaptation with Autostop - Clutch Pedal Sensor (for manual transmission) - Neutral Sensor of Gearbox (manual) - DC-Voltage stabilizer - 12V-Battery Current Sensor - Vacuum Sensor of power brakes - electric water pump - hood open detection sensor - vacuum brake pressure sensor - door open detection sensor - belt detection for driver 	
Modified Components	<ul style="list-style-type: none"> - Body Controller - 12V Battery - stronger Starter (VALEO) - climate control - intelligent generator control - tires - drag coefficient (by modifications of ride height, partially closed air intake ducts) 	
Engine	<p>1,4l Turbo Gasoline 90 kW, fuel consumption 7,8l (8,0l) inner city NEDC, 4,9l (5,0l) outer city, 5,9l (6,1l) combined, 138 g (142 g) CO₂</p> <p>with DSG 7,3l (7,5l) inner city, 5,2l (5,3l) outer city, 6,0l (6,1l) combined, 138 g (140 g) CO₂</p> <p>1,6l Diesel 77 kW, fuel consumption 5,2l (5,2l) inner city, 3,6l (3,8l) outer city, 4,1l (4,3l) combined, 109 g (113 g) CO₂</p> <p>2,0l Diesel 103 kW, fuel consumption 5,6l (5,6l) outer city, 4,0l (4,0l) inner city, 4,6l (4,6l) combined 119 g (120 g) CO₂</p>	



Start-Stop System Overview

FEV

	<p>with DSG 6,3l (6,3l) inner city, 4,5l (4,5l) outer city, 5,2l (5,2l) combined, 135 g (135 g) CO₂</p> <p>2,0l Diesel 103 kW 4WD, fuel consumption 6,4l (6,6l) inner city, 4,6l (4,6l) outer city, 5,3l (5,3l) combined, 137 g (139 g) CO₂</p> <p>2,0l Diesel 125 kW, fuel consumption 5,4l (5,6l) inner city, 4,1l (4,2l) outer city, 4,6l (4,7l) combined, 120 g (123 g) CO₂ with DSG 6,3l (6,3l) inner city, 4,6l (4,6l) outer city, 5,3l (5,3l) combined, 139 g (139 g) CO₂</p> <p>2,0l Diesel 125 kW 4WD, fuel consumption with DSG 6,7l (6,8l) inner city, 5,0l (5,0l) outer city, 5,6l (5,7l) combined, 147 g (149 g) CO₂ (brackets for Passat Variant)</p>	
Transmission	6-speed, manual or DSG 7 gear or DSG 6 gear	
SOP	10/2009	



Start-Stop System Overview

FEV

Volkswagen Polo (Micro-/Subcompact Car)

Starter/Generator Type / Supplier:	Enhanced Starter/Generator	
Functional Scope	Start-Stop and regenerative braking	
Battery System	12V Battery, Absorbent Glass Mat (AGM-Battery)	
Additional Sensors	<ul style="list-style-type: none"> - Display adaptation with Autostop - Clutch Pedal Sensor (for manual transmission) - Neutral Sensor of Gearbox (manual) - 12V-Battery Current Sensor - Vacuum Sensor of power brakes - door open detection sensor - belt detection for driver 	
Modified Components	<ul style="list-style-type: none"> - Body Controller - 12V Battery - stronger Starter - climate control - intelligent generator control - tires - drag coefficient (by modifications of ride height, partially closed air intake ducts) 	
Engine	<p>1,2l Gasoline, 3 cylinder, 51 kW, fuel consumption 6,8l inner city NEDC, 4,3l outer city, 5,2l combined, 119 g CO₂</p> <p>1,2l Diesel, 3 cylinder, 55 kW, fuel consumption 4,0l inner city, 2,9l outer city, 3,4l combined, 87 g CO₂</p> <p>1,2l Diesel, 3 cylinder, 55 kW, fuel consumption 4,1l outer city, 3,0l inner city, 3,4l combined 89 g CO₂</p> <p>1,6l Diesel, 4 cylinder, 66 kW, fuel consumption 4,6l inner city, 3,2l outer city, 3,7l combined, 96 g CO₂</p>	
Transmission	5-speed, manual	
SOP	2009	



Start-Stop System Overview

FEV

Volkswagen Scirocco (Midsize Car)

Starter/Generator Type / Supplier:	Enhanced Starter/Generator	
Functional Scope	Start-Stop and regenerative braking	
Battery System	12V Battery, Absorbent Glass Mat (AGM-Battery)	
Additional Sensors	<ul style="list-style-type: none"> - Display adaptation with Autostop - Clutch Pedal Sensor (for manual transmission) - Neutral Sensor of Gearbox (manual) - 12V-Battery Current Sensor - Vacuum Sensor of power brakes - door open detection sensor - belt detection for driver 	
Modified Components	<ul style="list-style-type: none"> - Body Controller - 12V Battery - stronger Starter - climate control - intelligent generator control - tires - drag coefficient (by modifications of ride height, partially closed air intake ducts) 	
Engine	<p>1,4l Gasoline, TSI, 1390 ccm, 4 cylinder, 90 kW, fuel consumption 7,6l inner city NEDC, 5,1l outer city, 6,0l combined, 139 g CO₂</p> <p>2,0l Diesel, TDI, 4 cylinder, 103 kW, fuel consumption 5,5l inner city, 4,0l outer city, 4,5l combined, 118 g CO₂</p> <p>with DSG, fuel consumption 5,9l inner city, 4,5l outer city, 4,9l combined, 129 g CO₂</p>	
Transmission	6-speed manual, 6-speed DSG	
SOP	2009	



Start-Stop System Overview

FEV

Volkswagen Touran (Van)

Starter/Generator Type / Supplier:	Enhanced Starter/Generator	
Functional Scope		
Battery System	XXX	
Additional Sensors	XXX	
Modified Components		
Engine	<p>I-4 1.2TSI Gasoline, 1197cm³, 77kW (105PS), 5.2-7.9 l/100km (45 – 30MPG) *</p> <p>I-4 1.6TDI Diesel, 1598cm³, 77kW (105PS), 4.1-5.5 l/100km (57– 43MPG) *, 4.2-5.1 l/100km (56– 46MPG) **</p> <p>I-4 2.0TDI Diesel, 1968cm³, 103kW (140PS), 4.6-6.5 l/100km (51– 36MPG) *, 5.0-7.0 l/100km (47– 34MPG) **</p>	
Transmission	6 - speed, manual *, 6 - speed DCT **	
SOP	2010-11	



Start-Stop System Overview

FEV

VW Sharan (Van)

Starter/Generator Type / Supplier:	Enhanced Starter/Generator	
Functional Scope		
Battery System	XXX	
Additional Sensors	XXX	
Modified Components		
Engine	<p>I-4 1.4TSI Gasoline, 1390cm³, 110kW (150PS), 6.1-9.2 l/100km (45 – 30MPG) *, 6.6-9.4 l/100km (56– 46MPG) **</p> <p>I-4 2.0TDI Diesel, 1968cm³, 85kW (115PS), 4.8-6.8 l/100km (51– 36MPG) *</p> <p>I-4 2.0TDI Diesel, 1968cm³, 103kW (140PS), 4.8-6.8 l/100km (49– 35MPG) *, 5.0-6.9 l/100km (47– 34MPG) **</p> <p>I-4 2.0TDI Diesel, 1968cm³, 125kW (170PS), 5.0-7.3 l/100km (47– 32MPG) *, 5.4-6.7 l/100km (44– 35MPG) **</p>	
Transmission	6 - speed, manual *, 6 - speed DCT **	
SOP	2010-11	



Start-Stop System Overview

FEV

VW Tiguan (SUV)

Starter/Generator Type / Supplier:	Enhanced Starter/Generator	
Functional Scope		
Battery System	XXX	
Additional Sensors	XXX	
Modified Components		
Engine	<p>I-4 1.4TSI Gasoline, 1390cm³, 90kW (122PS), 5.5-8.3 l/100km (43 – 28MPG)</p> <p>I-4 1.4TSI Gasoline, 1390cm³, 118kW (160PS), 5.7-8.5 l/100km (41 – 28MPG)</p> <p>I-4 2.0TDI Diesel, 1968cm³, 81kW (110PS), 4.8-6.3 l/100km (49– 37MPG) *</p>	
Transmission	6 - speed, manual	
SOP	2010-11	



Start-Stop System Overview

FEV

VW Touareg (SUV)

Starter/Generator Type / Supplier:	Enhanced Starter/Generator	
Functional Scope		
Battery System	XXX	
Additional Sensors	XXX	
Modified Components		
Engine	<p>V-6 3.6TSI Gasoline, 3597cm³, 206kW (280PS), 8.0-13.2 l/100km (29 – 18MPG)</p> <p>V-6 3.0TDI Gasoline, 2967cm³, 150kW (204PS), 6.3-8.2 l/100km (37 – 29MPG)</p> <p>V-6 3.0TDI Gasoline, 2967cm³, 180kW (245PS), 6.5-8.4 l/100km (36 – 28MPG)</p>	
Transmission	8 - speed, automatic	
SOP	2010-11	



4.3 Direct Starter

A direct starter uses direct injection and combustion to instantly restart the engine rather than replacing alternator and starter as in case of other start-stop systems. The principle of this system is to position the piston in an optimal position during the vehicle stop, so as to instantly restart the vehicle by injecting fuel into the cylinder.

4.3.1 System Layout

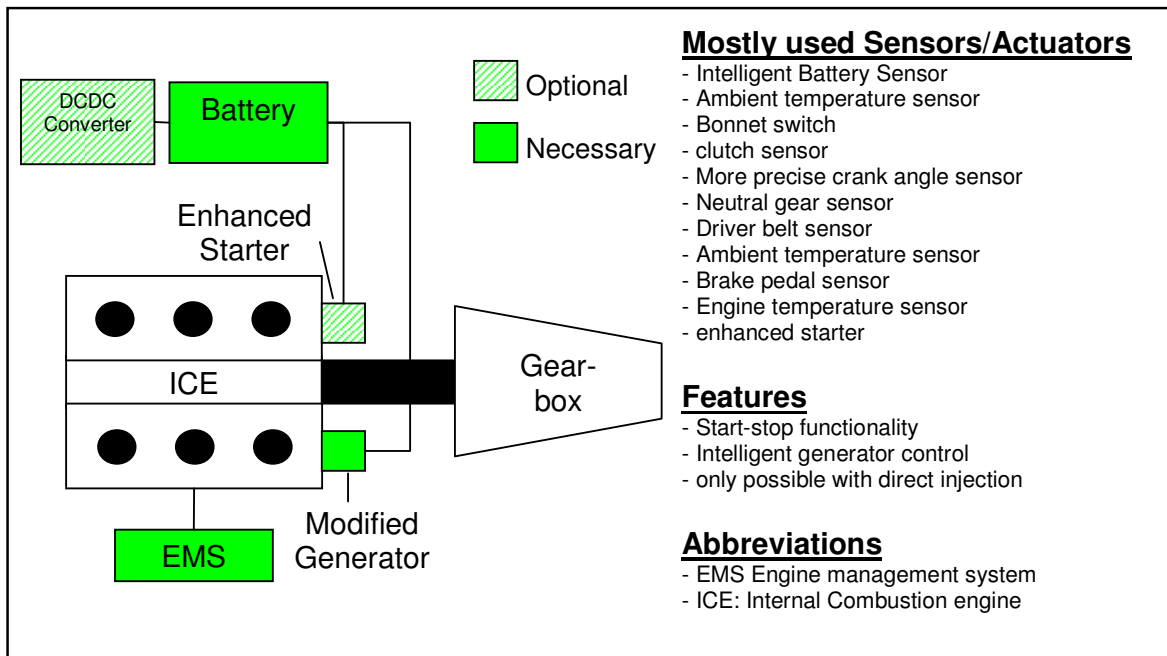

Figure: System layout of Direct Starter

4.3.2 Pros and Cons

Pro: Quick start

Cons: Emissions during restart

NVH during start

4.3.3 Supplier Solutions

4.3.3.1 Mazda Idling stop technology (i-Stop)

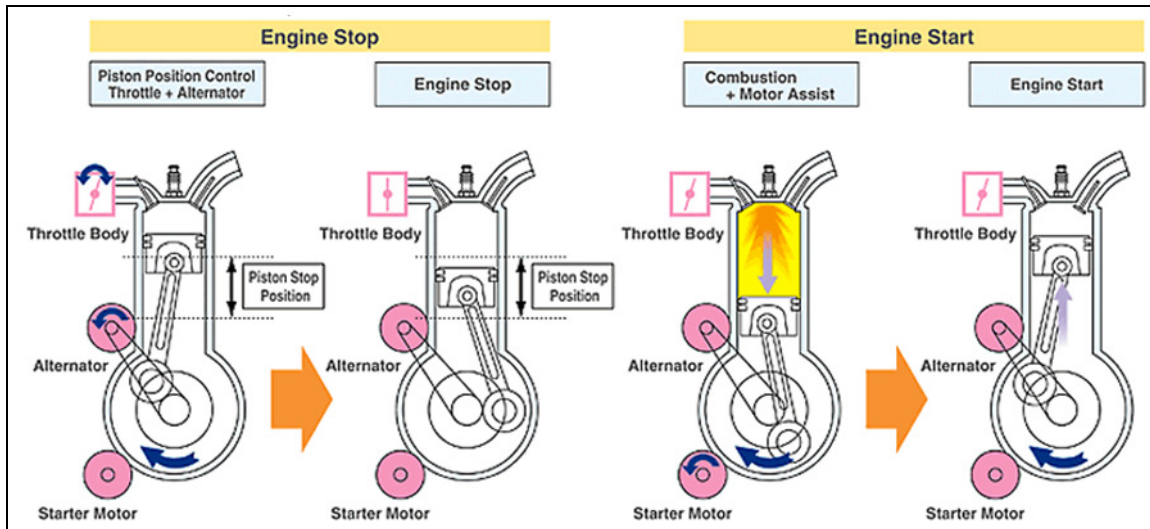



Figure: Operating principle of Mazda 'i-stop' [Source: Mazda Homepage]

Mazda i-stop system restarts the engine by directly injecting the fuel into the cylinder and igniting it to create downward piston force, while the vehicle is at standstill and the engine is stopped. The one of most important aspect is to recognize the cylinder with compression and expansion stroke and exactly stop their pistons within an appropriate position to have a right balance of air volumes, demanding precise control over the piston position during engine shutdown. Once all the pistons are at optimum position, the engine restarts is done by identifying the initial cylinder to fire, injecting fuel in this cylinder and allowing combustion to take place. Even at low engine speed, cylinders are continuously selected for ignition until the engine quickly reaches its idle speed.



4.3.4 In-Market Applications (2012)

Mazda 3 2.0 I MZR DISI

Starter/Generator Type / Supplier:	Direct Start/ Mazda iStop	
Functional Scope	<p>Start-Stop, no Recuperation.</p> <p>Motor-Stop If Vehicle Speed is stopped, Brake pedal is pushed and Gears are not engaged (neutral position) => ICE off ICE stops in defined position, one cylinder is in its power stroke</p> <p>Motor-Start: By pushing the clutch, the engine is started with short assist of the engine starter. Direct injection on the cylinder in power stroke starts up the engine.</p>	
Battery System		
Additional Sensors	<ul style="list-style-type: none"> - clutch sensor - neutral gear position sensor - brake pedal sensor 	
Modified Components	<ul style="list-style-type: none"> - direct Injection required - Alternator to stop crankshaft in defined position - DC-Voltage stabilizer 	
Engine	I4, Gasoline , 1998 cm ³ , DISI, Multi-Air, 4V, 111kW, Euro 5 6,8l/100km (34,6 MPG)	
Transmission	6-speed, manual	
SOP	2009	



Start-Stop System Overview

FEV

Mazda 5 2.0 I MZR DISI

Starter/Generator Type / Supplier:	Direct Start/ Mazda iStop	
Functional Scope	Start-Stop, no Recuperation. Motor-Stop If Vehicle Speed is stopped, Brake pedal is pushed and Gears are not engaged (neutral position) => ICE off ICE stops in defined position, one cylinder is in its power stroke Motor-Start: By pushing the clutch, the engine is started with short assist of the engine starter. Direct injection on the cylinder in power stroke starts up the engine.	
Battery System		
Additional Sensors	- clutch sensor - neutral gear position sensor - brake pedal sensor	
Modified Components	- direct Injection required - Alternator to stop crankshaft in defined position - DC-Voltage stabilizer	
Engine	I4, Gasoline , 1998 cm ³ , DISI, Multi-Air, 4V, 111kW, Euro 5 6,9l/100km (34,1 MPG)	
Transmission	6-speed, manual	
SOP	2009	



4.4 Integrated / Crankshaft Starter Generator (ISG / CSG)

The integrated starter generator (ISG) combines the conventional automotive starter and alternator (generator) into a single machine that is fitted directly to the engine crankshaft. The conventional starter is a low speed, high current DC machine, while the alternator is a variable speed 3 phase AC machine.

The ISG can have following important functions in a vehicle application

- **Start-Stop function :**
Switching off the engine when the vehicle is stationary which in turn saves fuel and restart instantly when the driver wants to proceed.
- **Recuperation:**
Configurations are also present to recuperate energy from regenerative braking
- **Power boosting:**
ISG can assist the ICE by providing supplementary power during fast acceleration
- **Power generation:**
Generating electric energy to be stored in energy storage devices (battery) converting mechanical energy available from rotating crankshaft to electrical energy.



4.4.1 System Layout

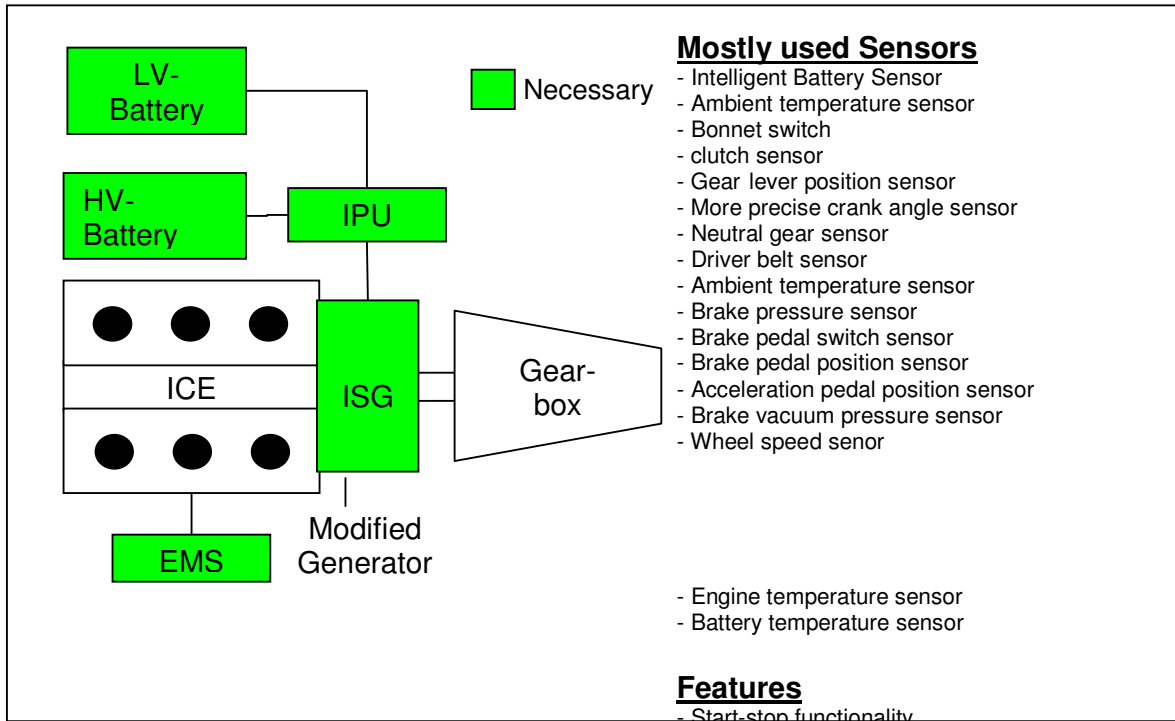

Figure: System layout of Integrated Starter Generator (ISG)

In a typical ISG layout as shown, the ISG is a short axis, large diameter permanent magnet synchronous motor mounted directly on the end of the engine crankshaft between the engine and the clutch in the gearbox bell housing. These systems are also known as CSG (Crankshaft Starter Generator). Vehicles with such a system are usually termed as Mild-hybrid as they not only provide functions as start-stop and recuperation but also provide additional boost during acceleration.

Following is a simply block diagram of integrated starter generator with list of sensor and actuator used for implementing start-stop feature.

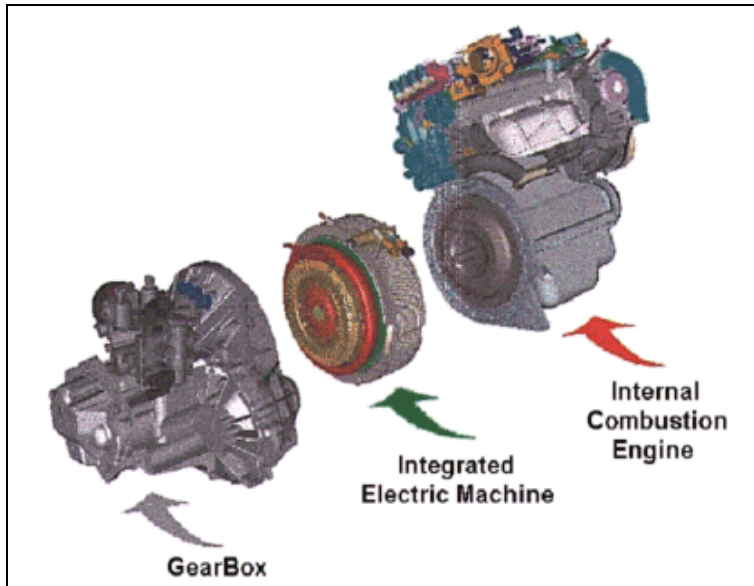

Figure: Layout of Integrated Starter Generator (ISG) or Crankshaft Starter Generator (CSG) [Source: Long, Schofield, Howe, Piron and Clelland 'Design of a switched Reluctance machine for Extended Speed Operation' IMEDC June 2003.]

4.4.2 Required Sensors and Actors

Following sensors are required for proper functioning of integrated starter generator system

1. Engine coolant temperature sensor
2. Bonnet switch sensor
3. Driver door sensor
4. Driver seat belt sensor (optional)
5. Driver seat detection sensor (optional)
6. Ambient temperature sensor (optional)
7. Steering wheel angle sensor (optional)
8. Brake light switch (optional)
9. Display with Start / Stop signal



4.4.3 Required Software Features

With new functionality additional requirements have to be fulfilled. To meet these new requirements, adaptation of existing functionalities or implementation of new functionalities has to be considered. Some of the software features to be added or implemented for this system are as follows.

1. Feature to detect driver presence.
2. Feature to stop engine.
3. Feature to restart engine instantly
4. Feature for recuperation
5. Feature for power generation
6. Feature to power assist (boost)

4.4.4 Pros and Cons

The main advantages of this system are

1. The ISG is crank mounted, thus avoids complexities and costs as that of the belt driven systems.
2. Transfers torque directly to the shaft.
3. Ability to reach high power level (42V limited to 10 KW, but high voltage can reach 30+ KW)
4. Allows power assist to that of engine.
5. Components such as drive belts, starter ring gear and pinion which are subject to wear are not necessary

The disadvantages of this system are

1. Major modification of power train.
2. Limitations to increase power train length.
3. With power assist feature, high voltage system needed
4. Higher costs compared to other solutions



4.4.5 Supplier Solutions

Some most representative ISG / CGS products identified in market are

1. Integrated Starter Alternator Damper (ISAD) from Continental.
2. DynaStart from ZF-Sachs.
3. Integrated Motor Generator (IMG) from Bosch.
4. Integrated Motor Assist (IMA) from Honda.

4.4.5.1 Integrated Starter Alternator Damper (ISAD) from Continental

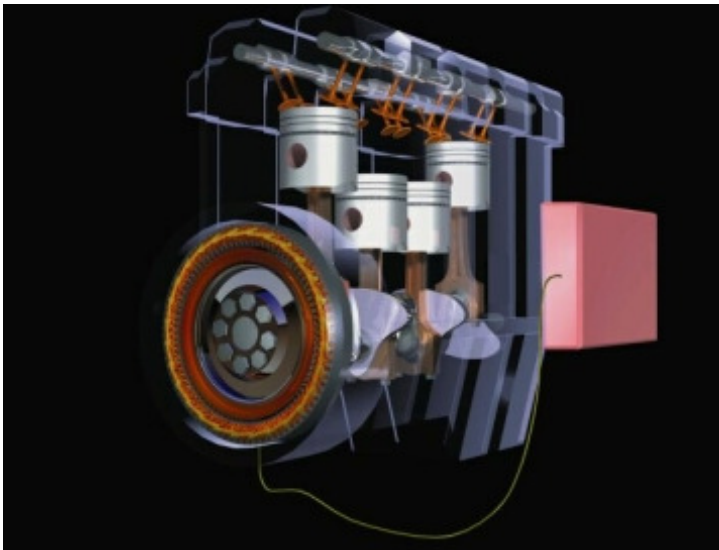

Figure: Layout of Integrated Starter Alternator Damper (ISAD) from Continental [Source: <http://www.kfztech.de/kfztechnik/elo/isad.htm>]

The Integrated Starter Alternator Damper (ISAD) system is an electric induction machine (IM) with a rotor instead of a flywheel mounted on the crankshaft between the internal combustion engine and transmission. ISAD takes over the function of the electric starter and the alternator and, at the same time, can balance out irregularities in the running engine and in the drive train so as to provide more comfort. An intelligent power electronics system makes this possible. It controls the ISAD operating state depending on the load status and the battery charge status.

***Start-Stop System Overview***

FEV

The start-stop function of the ISAD system is important for vehicles with a conventional internal combustion engine. The ISAD ECU (RED box) switches the engine off as soon as the vehicle has come to a stop if the engine has reached its working temperature. In a vehicle with automatic transmission, depressing the accelerator start the engine again in just a fraction of a second. This is due to the high ISAD starter torque which is silent and wear-free because of direct coupling with the crankshaft. ISAD switches the engine on and also supports accelerating with the driving torque it produces.

In the case of shift transmission, ISAD recognizes the beginning of the acceleration procedure when the clutch is engaged. The position of the gear lever is also sensed. If the driver puts the car into first or reverse gear, ISAD starts the engine and the acceleration procedure begins instantly. According to Continental, test stand trials with a mid-size-category vehicle resulted in fuel savings of around 9.0 percent for the city-traffic section of the new European driving cycle.



4.4.5.2 DynaStart from ZF-Sachs

DynaStart is developed by ZF-Sachs and is based on permanent magnet synchronous machine (PMSM). Coupled to the crankshaft of the internal combustion engine, DynaStart works both as a starter and a generator. Stator of the integrated starter generator is mounted with help of a carrier on the motor block of ICE and the rotor is secured to the flywheel which in turn is coupled to the crankshaft of the ICE as shown below.

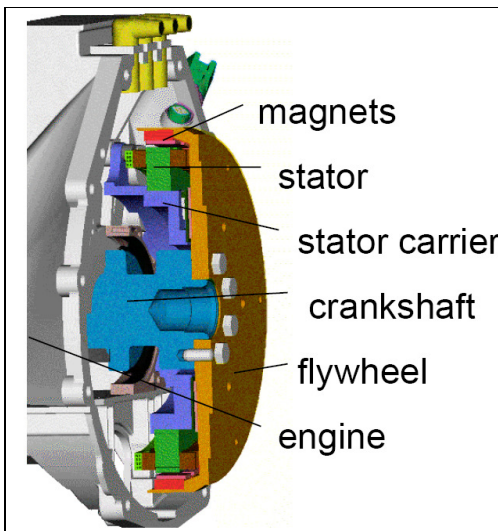

Figure: Layout of DynaStart from ZF [Source : 'Sachs DynaStart a CSG in the PowerNet, Jürgen Weimer, Mannesmann Sachs]

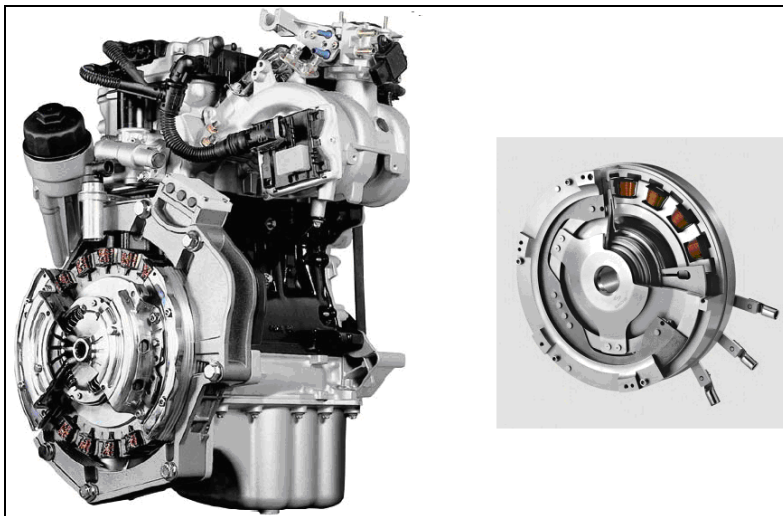

Figure: Layout of DynaStart from ZF mounted on engine crankshaft [Source: <http://www.kfztech.de/kfztechnik/elo/isad.htm>]



Start-Stop System Overview

FEV

	Mild hybrid	Full hybrid	Passenger car Plugin hybrid	Delivery truck Full hybrid	City bus Full hybrid
Power [kW]	4–20	20–70	50–100	25–130	100–200
Torque [Nm]	100–250	100–500	100–500	250–600	500–1,200
Voltage [V]	42–450	120–650	250–650	150–650	560–720
External diameters [mm]	240–325	240–345	240–345	240–480	345–480
Electric active length [mm]	50–80	55–105	55–105	55–105	100–200
Fuel reduction	up to 15%	up to 30%	up to 50%	up to 50%	up to 35%
Functions	Generator Start-stop Boost Recuperation	Generator Start-stop Boost Recuperation Electric drive operation	Generator Start-stop Boost Recuperation Electric drive operation	Generator Start-stop Boost Recuperation Electric drive operation	Generator Start-stop Boost Recuperation Electric drive operation
Electrical range [km]		1...5	15...45	1...5	1...5

Figure: DynaStart in application for different topology [Source: 'Power System for Commercial Vehicle' ZF Sachs Brochure]

Following is the product range available for DynaStart

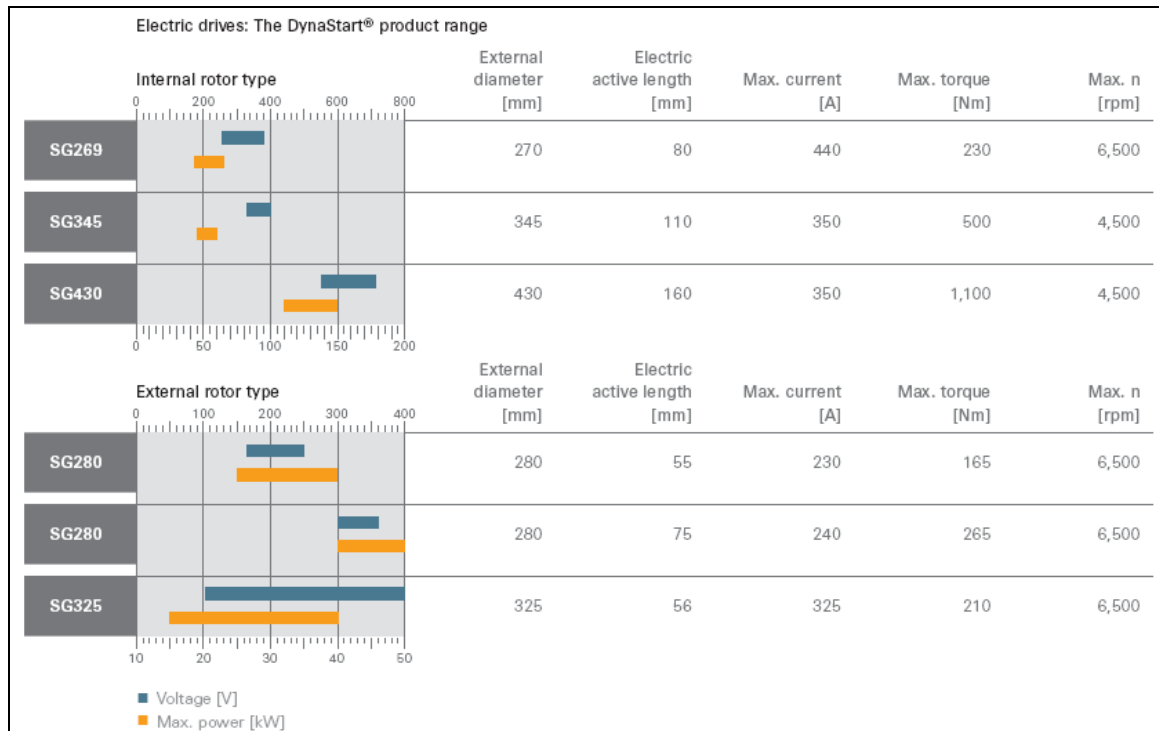

Figure: DynaStart product range [Source: 'Electric Motors and Hybrid Drives' ZF Sachs Brochure]



4.4.5.3 Integrated Motor Generator (IMG) from Bosch

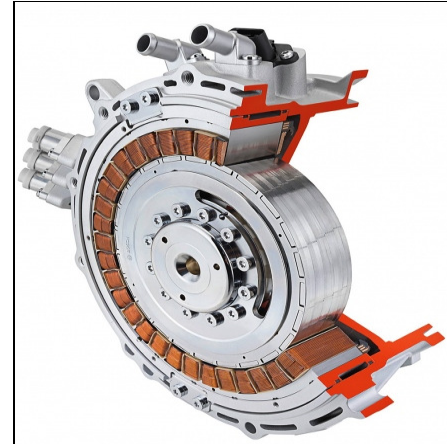
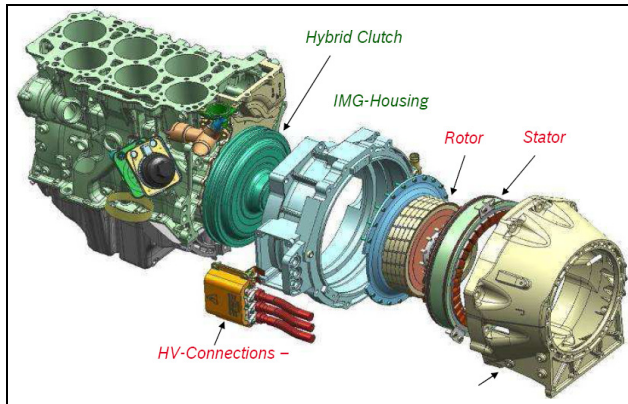

Figure: Layout of Bosch IMG, left figure showing engine (left-side) with motor (middle) and transmission (right side) and right figure showing integrated motor generator (IMG) [Source : Bosch Brochure]

Bosch has developed system based on integrated starter generator principle, calling them as Integrated Motor Generator (IMG), which it claims to be a modular unit to be integrated as add-on to the existing drive train. This system can be used for mild and full hybrid vehicles. Some salient features of the Bosch system are it has permanent magnet-excitation for high efficiency, concentric windings for compact axial length and with up to 50 KW, 350 Nm performance systems. The Bosch systems are available since 2010 and find application in Porsche Cayenne and Volkswagen Touareg which are full hybrid vehicles.



4.4.5.4 Honda - Integrated Motor Assist (IMA)

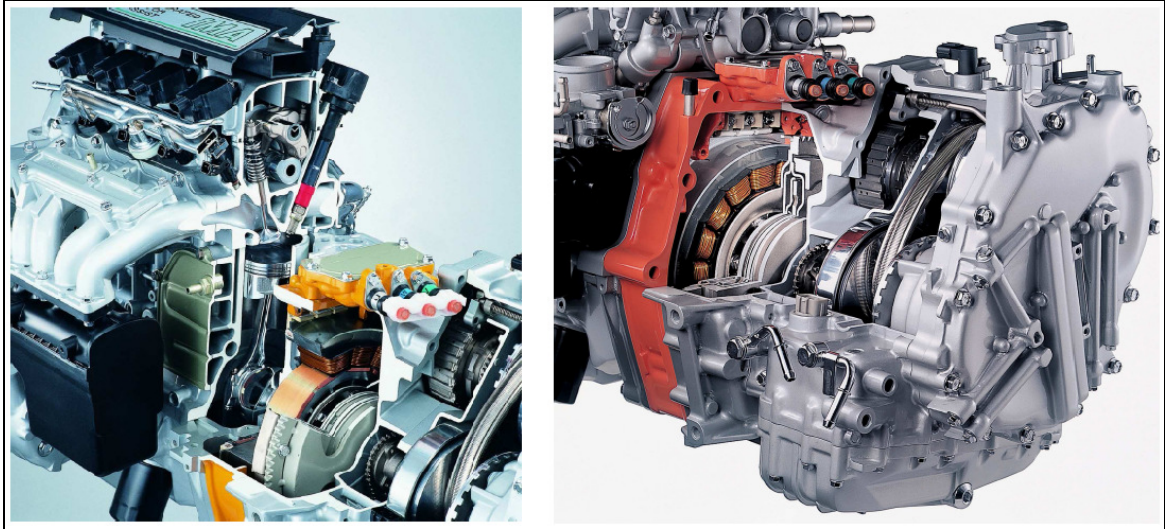

Figure: Layout of Honda IMA, left figure showing engine (left-side) with motor (right side) and right figure showing motor (right-side) with continuous variable transmission CVT (right side) [Source : Honda Homepage]

Honda's in-house developed technology on similar principle is popularly known as Integrated Motor Assist (IMA) and is in application since early 2000. It uses a gasoline engine with a compact permanent magnet electric motor/generator mounted between engine and transmission similar to parallel hybrid powertrain system. The motor/generator serves as a starter motor, generator for recuperating brake energy during braking, engine balancer and also assists engine as and when required. The engine is the prime power provider in most driving situation. In addition to IMA motor a standard 12V battery and a starter are also present, which are used when IMA motor is not able to start the engine (e.g. engine coolant temperature, IMA battery temperature and IMA battery SOC are below a predefined value).

Following figure shows application of IMA in various driving conditions



Start-Stop System Overview

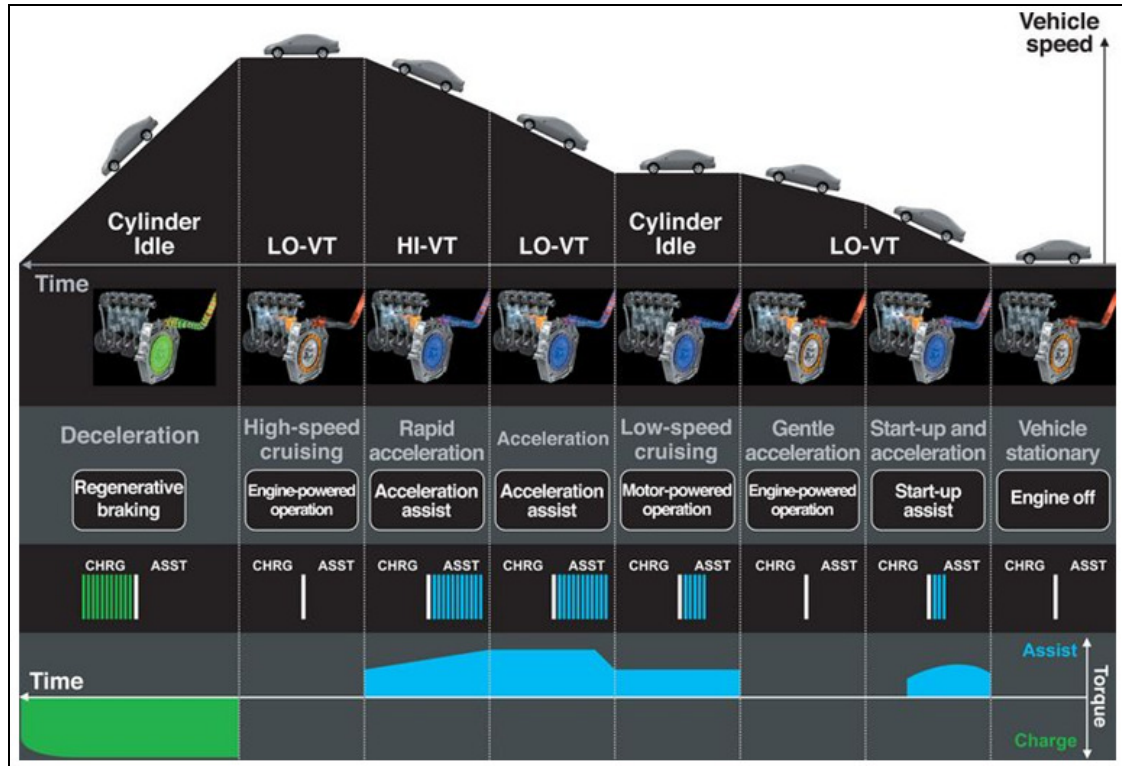



Figure: IMA application in various driving situation [Source: http://wikicars.org/en/Integrated_Motor_Assist (IMA)]



4.4.6 In-Market Applications (2012)

Honda CR-Z (Compact Car)

Starter/Generator Type / Supplier:	CSG	
Functional Scope	<p>Mild Hybrid, Start-Stop, Recuperation</p> <p>Recuperative Braking is engaged when the foot is lifted from the accelerator (Volt Control alternator management system)</p> <p>Engine shut-off and restart while still moving between 8-20kph (depending on gearbox, neutral)</p>	
Battery System	<p>Panasonic EV Energy Ni-MH (Nickel Metal Hydride) Battery</p> <p>Rated Capacity 5.75 Ah</p> <p>Battery pack voltage 100.8 V</p>	
Additional Sensors	vehicl	
Modified Components	<p>- DC Brushless Motor (Permanent Magnet AC Synchronous)</p> <p>- 10 KW (14 PS) @ 1500 rpm</p>	
Engine	<p>I-4 1.5 litre-i-VTEC, Gasoline, 16 SOHC, 1497cm³, 84kW, 4.4l-6.1 l/100km (53.43 – 38.53 MPG)</p>	
Transmission	6-speed, manual (FWD)	
SOP	2011	



Start-Stop System Overview

FEV

Honda Jazz Hybrid (Compact Car)

Starter/Generator Type / Supplier:	CSG	
Functional Scope	<p>Mild Hybrid, Start-Stop, Recuperation</p> <p>Recuperative Braking is engaged when the foot is lifted from the accelerator (Volt Control alternator management system)</p> <p>Engine shut-off and restart while still moving between 8-20kph (depending on gearbox, neutral)</p>	
Battery System	XXX	
Additional Sensors	XXX	
Modified Components	<p>- DC Brushless Motor (Permanent Magnet AC Synchronous)</p> <p>- 10 KW (14 PS) @ 1500 rpm</p>	
Engine	I-4 1.3i-DSI-iVTEC, Gasoline, 8-value SOHC, 1497cm ³ , 84kW, 4.4l-4.6 l/100km (53.43 – 51.13 MPG)	
Transmission	CVT (FWD)	
SOP	2011	



Start-Stop System Overview

FEV

Honda Insight (Compact Car)

Starter/Generator Type / Supplier:	CSG	
Functional Scope	<p>Mild Hybrid, Start-Stop, Recuperation</p> <p>Recuperative Braking is engaged when the foot is lifted from the accelerator</p> <p>Engine shut-off and restart while still moving between 8-20kph (depending on gearbox, neutral)</p>	
Battery System	XXX	
Additional Sensors	XXX	
Modified Components	<ul style="list-style-type: none"> - DC Brushless Motor (Permanent Magnet AC Synchronous) - 10 KW (14 PS) @ 1500 rpm 	
Engine	I-4 1.3i-DSI-iVTEC, Gasoline, 8-value SOHC, 1497cm ³ , 84kW, 4.2l-4.6 l/100km (53.43 – 51.13 MPG)	
Transmission	CVT (FWD)	
SOP	2011	



5 Recommendation on Future Start-Stop System

The emission target of 95 grams/km CO₂, which has to be fulfilled by 2020 as of today, cannot be reached with conventional technology. Start-Stop technology is a promising candidate, but the existing technologies have to be improved for gaining further CO₂ reduction.

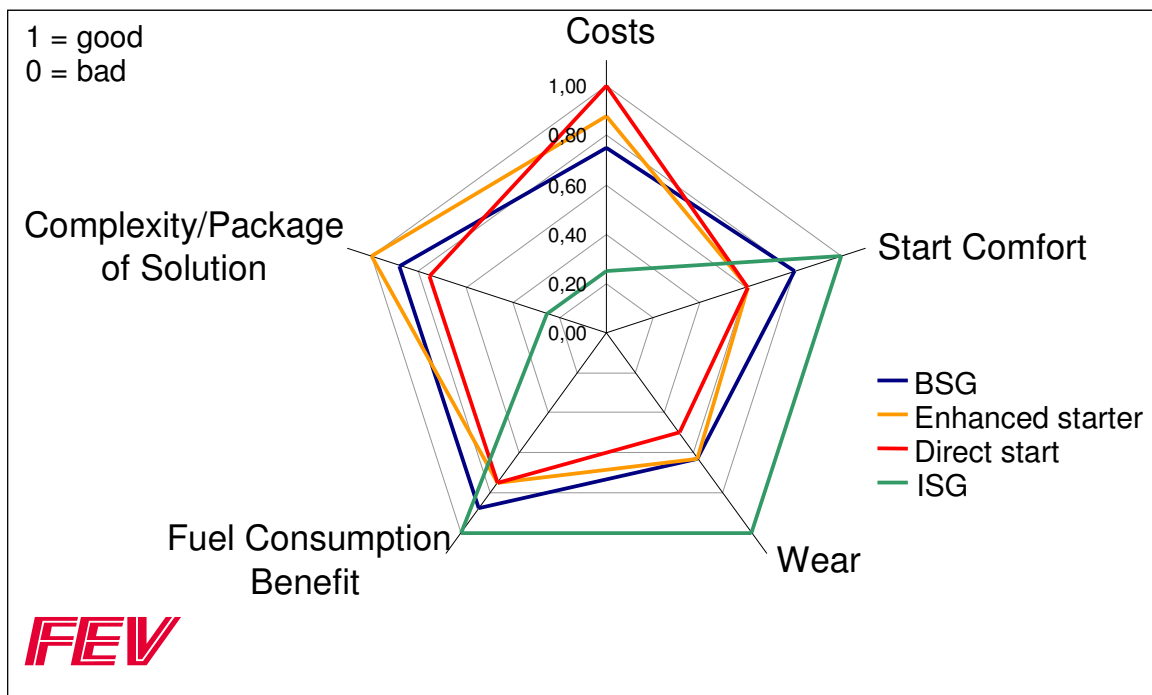

Figure: Comparison between different start-stop systems

The newly developed start-stop systems provide the potential for decreasing losses of energy during braking (thermal energy) by using a secondary energy storage system with higher voltage level and the possibility to store higher density of energy within secondary storage systems (e.g. ultra capacitors). The regenerated energy can be used in different ways. On the one hand the 12V electrical system can be supported and therefore the alternator load on the combustion engine can be reduced, or on the other hand there is the possibility for using the recuperated energy to boost the com-

**Recommendation on Future Start-Stop System**

FEV

bustion engine under certain driving situation. Therefore a mild hybrid solution seems to be a promising solution for future applications for bigger engines.

To evaluate different start-stop systems mentioned above a decision matrix based on a spider diagram helps to understand the complex dependencies. The spider diagram is based on FEV's experience from past and ongoing projects.

The two most competitive start-stop systems in near future are the BSG and the enhanced starter combined with an enhanced alternator for regenerative braking. As indicated in the spider diagram above it is evident that both systems have almost similar advantages such as ease of packaging, fuel consumption benefits and comparable costs. Compared to these systems the ISG is a high-cost solution but it gives much more possibilities for hybrid functionalities.

Further advantage of the BSG is the possibility to leave out the conventional starter in small engine applications. Keeping the existing layout of the system and to incur comparable additional costs for integrating the start-stop system, a belt-driven Starter-Generator with ability to boost might be the solution.

Regarding the start comfort, which is also a big issue for customers, the ISG is the best solution followed by the BSG. The advantage of ISG is the possibility to ramp up the speed of the combustion engine and then start injection and ignition. Therefore almost no vibration occurs during restart. The BSG has similar advantages towards the enhanced starter and the direct start, but cannot reach that high engine speeds.

Cost factor is very important for manufacturers and therefore all systems which are based on the existing system are less cost intensive than the hybrid version.

Complexity of the start-stop system is also important for the manufacturers. The more complex the integration becomes, more costs during development phase occur. Therefore the enhanced starter is the least complex system. The BSG needs further adaptations of the belt drive system and the direct start requires the most com-

**Recommendation on Future Start-Stop System**

FEV

plex adaptations inside of the engine control unit. Most complex solution is the ISG, because the complete drive train has to be adapted.

For all the above mentioned systems, a new layout of the electrical system seems to be necessary. A second energy storage system with a higher voltage than 12V electrical system (e.g. 48V) would have impact on recuperation performance. The second energy storage system is needed because higher power during recuperation cannot be stored inside of a normal 12V battery or an AGM-battery (Absorbant Glass Mat). Only storage systems like Lithium-Ion batteries or capacitor based storage systems are capable of backing high recuperative power demands.

Energy consumers of the vehicle with higher power demand might also be sourced by the higher electrical system voltage (e.g. electric power steering, etc.).

A DC/DC-converter should be included between the 48V electrical system and the 12V electrical system, with the possibility to store the recuperated energy from high voltage electrical system towards the 12V electrical system and to recharge the 12V battery. An intelligent electrical system management should be used, which controls the energy flow between the two electrical systems and also controls the regenerative/boosting energy flow.

The boost function of the BSG is restricted by the power transfer limitations of the belt system. With the currently available systems, only limited power can be transferred to the belt and towards the crankshaft of the combustion engine, but with further development of these systems it might be possible to reach a relevant power which has an additional influence on the fuel consumption.

In case the challenges of the power transfer of the belt can not be accomplished, the next step in hybridization points towards the ISG (Integrated Starter Generator). However, the ISG has a major impact on costs compared to its competitive systems and provides additional hybrid drive functionalities to the start-stop system, however this leads to higher system complexity.



6 Appendix

6.1 Additional cars with unknown Start-Stop technology

Audi A1 (Micro/Subcompact Car)

Starter/Generator Type / Supplier:	NA	
Functional Scope	<p>Start-Stop function only when...</p> <ul style="list-style-type: none"> • the driver's door and the bonnet are closed • the driver is wearing a seat belt • the vehicle has been driven at faster than 4 km/h before stopping • the vehicle is not pulling a trailer <p>Engine will not be switched off when ...</p> <ul style="list-style-type: none"> • the engine temperature is still too low • the difference between the interior temperature and the temperature selected via the air conditioning system is still too great • the outside temperature is very high or very low • the windscreen is being de-iced • the optional parking aid or the optional park assist is activated • the battery charge is too low 	



Appendix

FEV

	<ul style="list-style-type: none"> • the steering wheel is at a sharp angle or is being turned • reverse gear is engaged • the road is steep <p>Engine is started automatically when...</p> <ul style="list-style-type: none"> • the vehicle rolls forward • the windscreen is being de-iced • there is a large difference between the interior temperature and the temperature selected via the air conditioning system • the brake pedal has been depressed several times in succession • the battery charge is too low • power consumption is too high 	
Battery System	XXX	
Additional Sensors	XXX	
Modified Components	XXX	
Engine	<p>I-4 1.2 TFSI, Gasoline, 1197cm³, 63kW (86PS), 4.4l-6.2 l/100km (53 – 38 MPG)</p> <p>I-4 1.4 TFSI, Gasoline, 1390cm³, 90kW (122PS), 4.4l-6.8 l/100km (53 – 34 MPG)</p>	
Transmission	<p>5-speed, manual (FWD)</p> <p>6-speed, manual (FWD)</p>	
SOP	2010	



Appendix

FEV

Audi A3 (Compact Car)

Starter/Generator Type / Supplier:	NA	
Functional Scope	Same as for A1 series	
Battery System	XXX	
Additional Sensors	XXX	
Modified Components	XXX	
Engine	I-4 1.2 TFSI, Gasoline , 1197cm ³ , 77kW (105PS), 4.7-6.7 l/100km (50 – 35 MPG) I-4 1.4 TFSI, Gasoline 1390cm ³ , 92kW (125PS), 4.8-7.3 l/100km (49 – 32 MPG)	
Transmission	6-speed, manual (FWD)	
SOP	2009	

Audi A4 (Mid-/Full size car)

Starter/Generator Type / Supplier:	NA	
Functional Scope	Same as for A1 series	
Battery System	XXX	
Additional Sensors	XXX	
Modified Components	XXX	
Engine	I-4 2.0 TFSI, Gasoline 2000cm ³ , 132kW (180PS), 5.4-8.4 l/100km (44 – 28 MPG)	
Transmission	6-speed, manual (FWD)	
SOP	2010	



Appendix

FEV

Audi A5 (Sports Car)

Starter/Generator Type / Supplier:	NA	
Functional Scope	Same as for A1 series	
Battery System	XXX	
Additional Sensors	XXX	
Modified Components	XXX	
Engine	I-4 2.0 TFSI, Gasoline 1984cm ³ , 132kW (180PS), 5.4-8.4 l/100km (44 – 28 MPG)	
Transmission	6-speed, manual (FWD)	
SOP	2010	

Audi Q3 (SUV)

Starter/Generator Type / Supplier:	NA	
Functional Scope	Same as for A1 series	
Battery System	XXX	
Additional Sensors	XXX	
Modified Components	XXX	
Engine	I-4 2.0 TFSI, Gasoline 1984cm ³ , 125kW (170PS), 6.1-9.5 l/100km (38 – 25 MPG)	
Transmission	6-speed, manual (AWD)	
SOP	2010	



Appendix

FEV

Renault Scénic (Mid-/Full size car)

Starter/Generator Type / Supplier:	NA	
Functional Scope		
Battery System	XXX	
Additional Sensors	XXX	
Modified Components	XXX	
Engine	1.6l dCi, Diesel , Turbo, 1598cm ³ , 96 kW, fuel consumption, inner city 5,1l, outer city 4,0l, combined 4,4l, 115 g CO ₂	
Transmission	6-speed, manual (FWD)	
SOP	2011	

Renault Laguna (Mid-/Full size car)

Starter/Generator Type / Supplier:	NA	
Functional Scope		
Battery System	XXX	
Additional Sensors	XXX	
Modified Components	XXX	
Engine	2.0l dCi, Diesel , Turbo, 1995cm ³ , 110 kW, fuel consumption, inner city 5,5l, outer city 4,0l, combined 4,5l, 118 g CO ₂	
Transmission	6-speed, manual (FWD)	
SOP	2011	

Source: <http://www.renault.com>



7 Reference